

**Pages**

**PRESEEDER**<sup>®</sup>  
LANDSCAPING TILLER

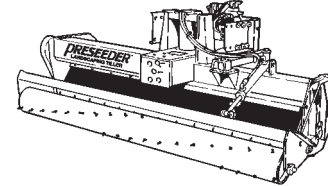
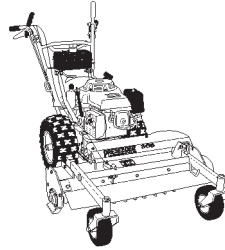

2

**'scape rake**

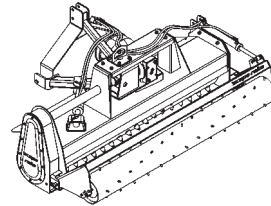

5

**Level Best**  
LASER GRADING BOX

**New Item!**

**New Slope-Tach**

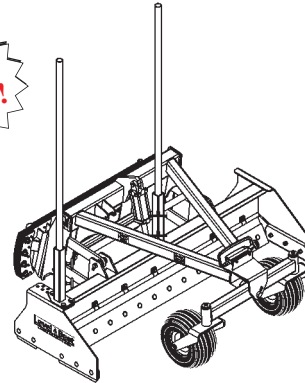

6

**TACH-ALL**<sup>™</sup>  
QUICK ATTACH

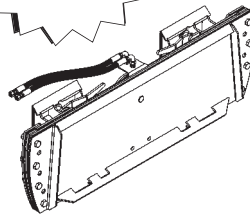

12

**Loader Attachments & Cutting Edges**

14

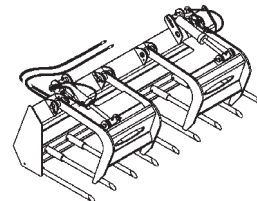
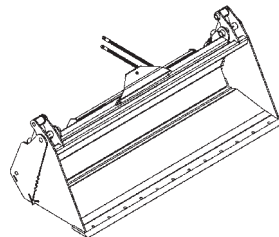
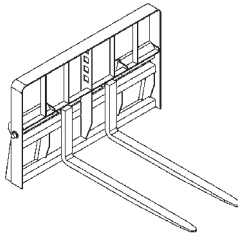
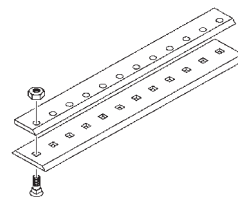
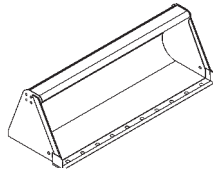
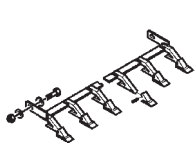

**Loader Fit List**

32





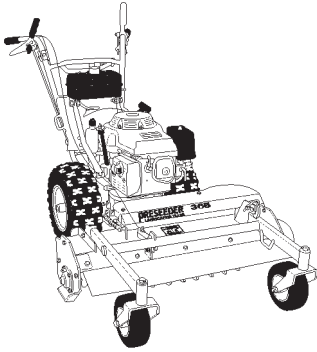

- Angles Left & Right
- Tills, Levels & Rakes

**MODEL 365**

**Standard Features:**

- 36"- wide rotor with teeth welded in helical pattern
- 13-hp Honda Engine
- Hydrostatic transmission w/reverse
- Differential Lock
- 10-Position Depth Control
- Angles Left, Right or Straight

<u>Model</u>	<u>Rotor Type</u>	<u>Engine HP</u>	<u>Machine Weight</u>	<u>Order Code</u>
365	36", Abrasion-resistant teeth	13	440 lbs.	200-030-000
365	36", Carbide teeth	13	440 lbs.	200-032-000

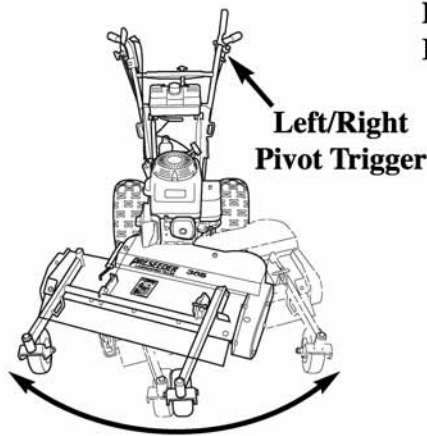

Rotor Drive & Brake Control

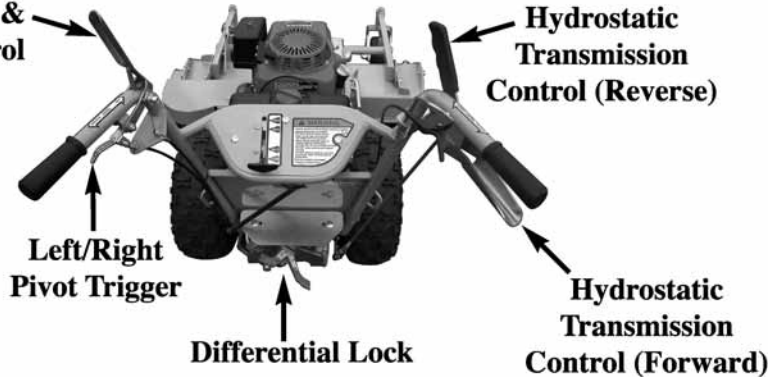

Transmission Engaged/Disengaged Control



10-Position Depth Adjustment



Adjustable Ground Speed Control

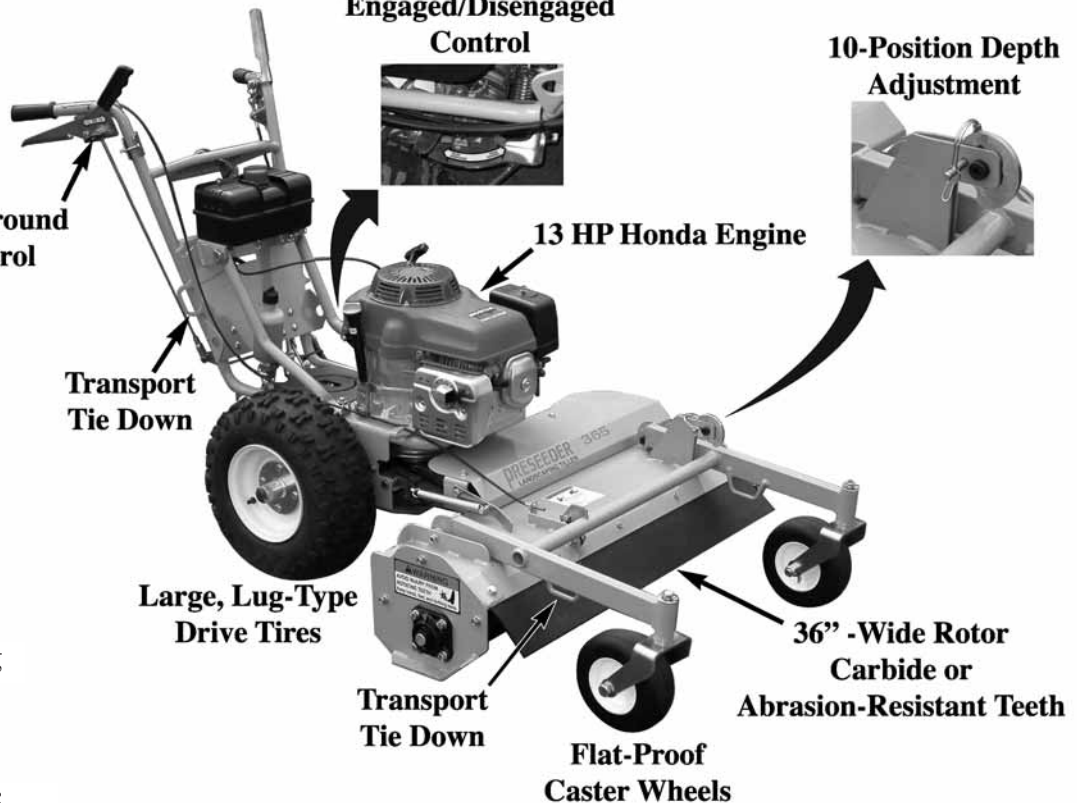

Patent Pending

**SPECIFICATIONS:**

Engine:	Easy-starting 13-hp. Honda GVX390 Full pressure lubrication
Transmission:	Hydrostatic Forward & Reverse
Differential Lock:	Standard Equipment, Foot pedal engagement
Rotor Width:	36"-wide, helical tooth pattern
Rotor Final Drive:	#40 O-ring Chain
Depth Control:	10-Position, Manually-adjusted
Controls:	Adjustable Ground Speed Control, 6-Position Angle Adjustment, Low-Effort PTO Clutch
Overall Width:	42-3/8 inches
Machine Weight:	440 lbs.

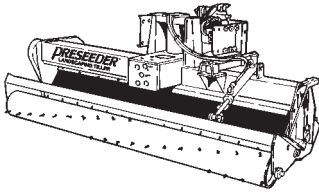

- Carbide Teeth
- Hydraulic Angle
- Tills, Levels & Rakes
- Adjust depth from tractor seat

**HYDRAULIC ANGLE - MODELS 605, 725 & 805**

**Standard Features:**

- Rotor with carbide teeth welded in helical pattern
- 3-position 3-point hitch
- Hydraulic depth control cylinder
- Rear roller with spikes
- Infinitely-adjustable hydraulic angle cylinder
- 540 RPM PTO shaft
- Replaceable skid shoes

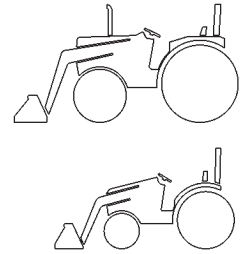

**Requirements:**

- One or two tractor-mounted hydraulic remote valves

Note: If tractor has only one hydraulic remote, the diverter valve option is required



<u>Model</u>	<u>Rotor Width</u>	<u>Recommended Tractor PTO HP</u>	<u>Machine Weight</u>	<u>Order Code</u>
605	60"	20 to 30	1055 lbs.	200-019-000
725	72"	25 to 45	1160 lbs.	200-022-000
805	80"	25 to 45	1215 lbs.	200-020-000

**Option:**

- Electro-Hydraulic diverter valve

200-015-000

(For use on tractor w/only one remote valve)

**Recommended Tractors**

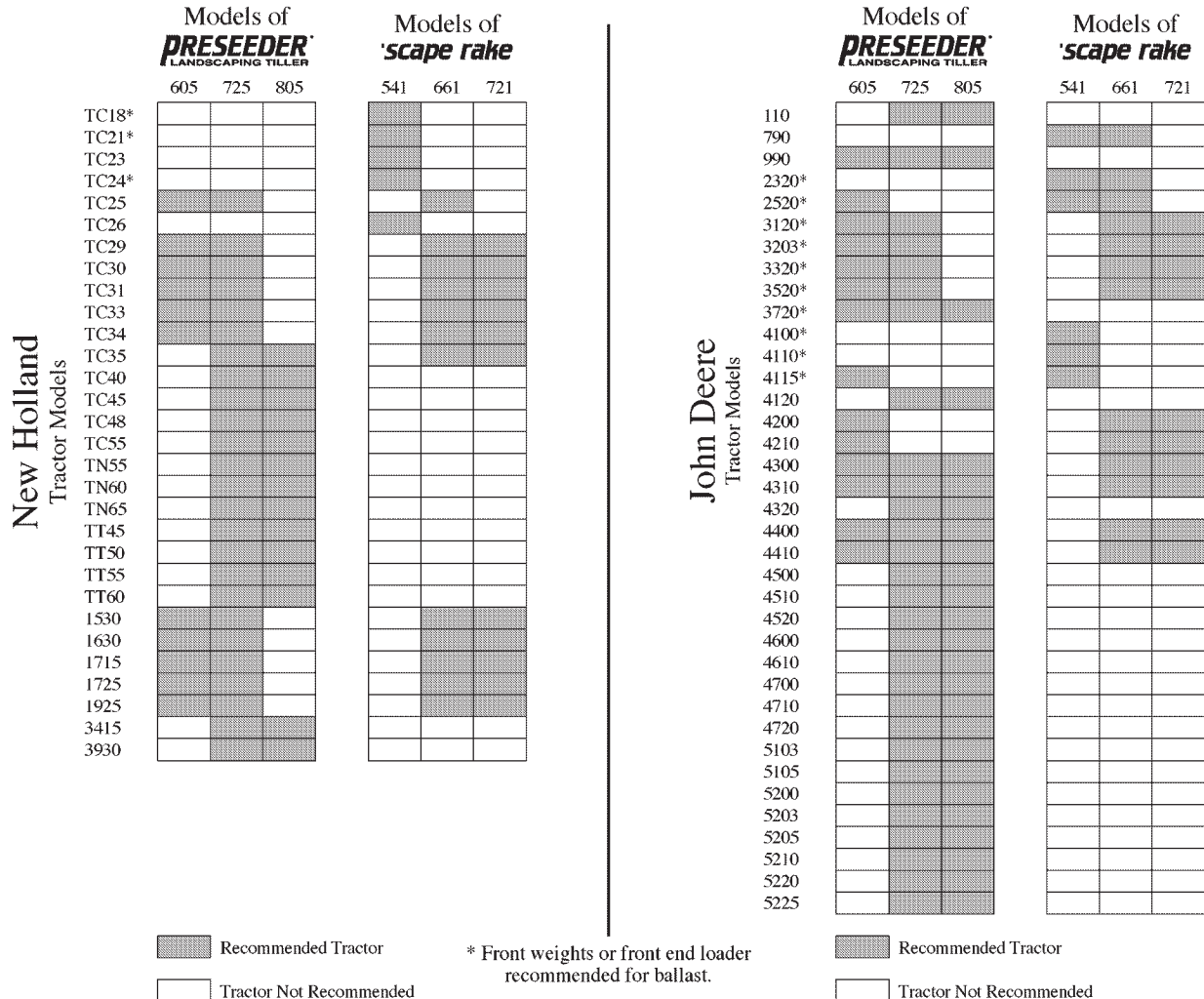

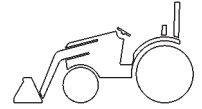
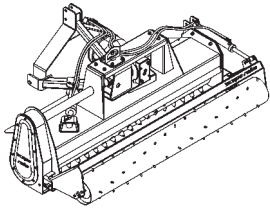

### MODELS 541, 661 & 721

**Standard Features:**

- Rotor with carbide teeth welded in helical pattern
- 5-position manual angle control, optional hydraulic angle
- Manual depth adjustment, optional hydraulic cylinder
- Rear roller with spikes
- 540 RPM PTO shaft

**Requirements:**

- One or two tractor-mounted hydraulic remote valves are needed when hydraulic options are added to 'Scape Rake

- Carbide Teeth
- Tills, Levels & Rakes
- Landscaping rake for smaller tractors
- Rear roller



Model	Rotor Width	Recommended Tractor PTO HP	Machine Weight	Order Code
541	54"	14 to 20	880 lbs.	200-027-000
661	66"	16 to 30	935 lbs.	200-028-000
721	72"	20 to 30	955 lbs.	200-029-000

**Options:**

- Hydraulic Depth Control 200-316-000
- Hydraulic Angle Control 200-315-000
- Electro-Hydraulic diverter valve 200-015-000

(May be required when both hydraulic options are chosen)

## Recommended Tractors

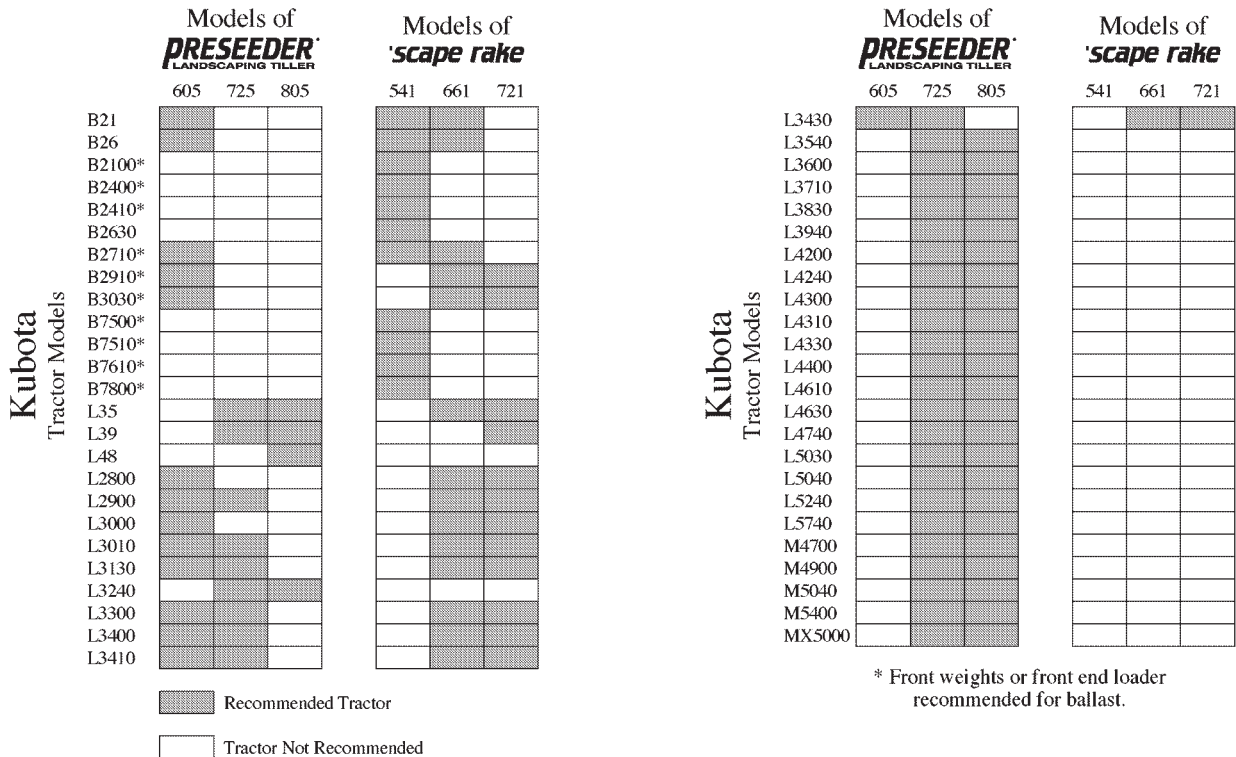

**PARA-LEVEL - SINGLE**

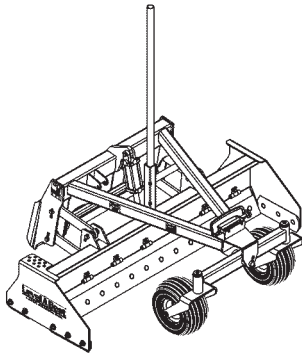

**Manual Control:**

- Push-Pull design pushes and pulls material for fine grading
- Stable platform for fine grading
- Oscillating front axle smooths out rough ground
- Fine grading at a budget price

**Standard Features:**

- Foam-filled tires
- Powder Coated Finish
- Reversible Cutting Edge on all sides
- Convex Mirror allows material visibility
- Hoses w/flush-face couplers
- 1-1/2" Dia. Mast Pole

**Requirements:**

- Auxiliary hydraulics on skid steer

- Push-Pull Design
- Fine-grade finish
- Universal skid steer mount
- One cylinder controls depth

Model	Box Width	Box Capacity		Recommended Skid Steer HP	Shipping Weight	Order Code
		Front	Rear			
PL72	72"	11.5	7.0	42-60	1575 lbs.	315-067-000
PL84	84"	13.4	8.0	49-70	1630 lbs.	315-068-000
PL96	96"	15.3	9.0	56-80	1695 lbs.	315-069-000

\* Price does not include hydraulics & laser controls. See Hydraulic and Laser Controls sections below.

**HYDRAULIC VALVE PACKAGE for Laser Controls**

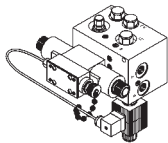

**Hydraulic Package:**

- Proportional Valve (Except Laser Alignment)
- Hoses & Fittings
- Solenoid Cable (Except Trimble)
- Remote Switch for in-cab grade control (Except Trimble & MEI/Mikrofyn)

**Features:**

- Machine control ready
- Laser controls added easily

**Hydraulics for:**

Hydraulics for:	Laser Alignment	PT	Order Code
Topcon(w/cables)	Proportional	Proportional	000-166-472
Apache	Proportional	Proportional	000-166-473**
MEI/Mikrofyn	Proportional	Proportional	000-166-471
Trimble	Proportional	Proportional	000-166-474
			000-166-482

**Cable Kit for:**

Trimble Controls	000-200-148
------------------	-------------

\*\* Note: Does not include sensor cable.

**LASER ALIGNMENT CONTROLS**

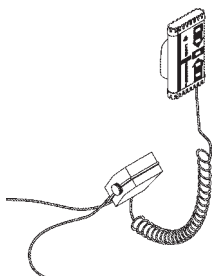

**Laser Control Package:**

- Control Panel
- 360° Sensor
- Power Cable
- Sensor Cable

**Features:**

- Manual override
- Consistently "On Grade"
- More accurate and efficient

**Laser Alignment Controls(C)**

**Order Code**  
000-200-054

**APACHE CONTROLS**

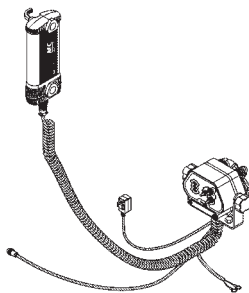

**Laser Control Package:**

- Control Panel
- 360° Sensor
- Power Cable
- Sensor Cable

**Features:**

- Manual override
- Consistently "On Grade"
- More accurate and efficient

**Apache Controls(A)** **Order Code**  
000-200-095

**TRACTOR HITCH - Enables Para-Level box to be used with a tractor**

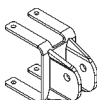

Box Width	Shipping Weight	Order Code
72" thru 96"	7 lbs.	315-575-000



### PARA-LEVEL - SLOPE

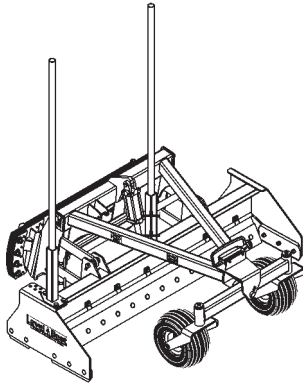

**Manual Control:**

- Push-Pull design pushes and pulls material for fine grading
- Stable platform for fine grading
- Oscillating front axle smooths out rough ground
- Fine grading at a budget price
- Slope-Tach provides cross-slope operation

**Standard Features:**

- Foam-filled tires
- Powder Coated Finish
- Reversible Cutting Edge on all sides
- Convex Mirror allows material visibility
- Hoses w/flush-face couplers
- 1-1/2" Dia. Mast Pole Qty. of 2

**Requirements:**

- Auxiliary hydraulics on skid steer

- Push-Pull Design
- Fine-grade finish
- Universal skid steer mount
- One cylinder controls depth
- Two cylinders control slope

Model	Box Width	Box Capacity		Recommended Skid Steer HP	Shipping Weight	Order Code
		Front	Rear			
PL72	72"	11.5	7.0	42-60	1990 lbs.	315-081-000
PL84	84"	13.4	8.0	49-70	2050 lbs.	315-082-000
PL96	96"	15.3	9.0	56-80	2110 lbs.	315-083-000

\* Price does not include hydraulics & laser controls. See Hydraulic and Laser Controls sections below.

### HYDRAULIC VALVE PACKAGE for Laser Controls

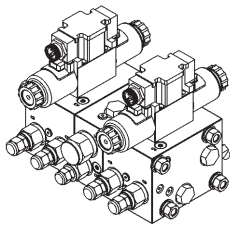

**Hydraulic Package:**

- Proportional Valve (Except Laser Alignment)
- Hoses & Fittings
- Solenoid Cable (Except Trimble)
- Remote Switch for in-cab grade control (Except Trimble, MEI/Mikrofyfyn & Laser Alignment)

**Features:**

- Machine control ready
- Laser controls added easily

**Hydraulics for:**

Laser Alignment	PT
Topcon (w/cables)	Proportional
Apache	Proportional
MEI/Mikrofyfyn	Proportional

**Order Code**

000-166-476
000-166-477**
000-166-475
000-166-479

\*\* Note: Does not include sensor cable.

### APACHE CONTROLS

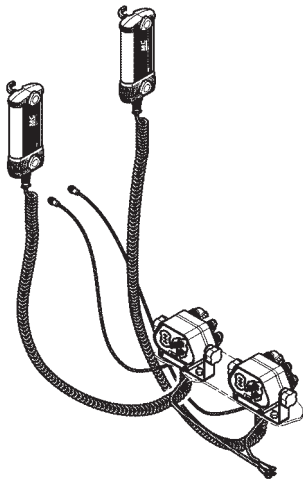

**Laser Control Package:**

- Control Panel Qty. 2
- 360° Sensor Qty. 2
- Power Cable Qty. 2
- Sensor Cable Qty. 2

**Features:**

- Manual override
- Consistently "On Grade"
- More accurate and efficient

**Order Code**  
Apache Controls(A) Qty. 2 of 000-200-095

### LASER ALIGNMENT CONTROLS

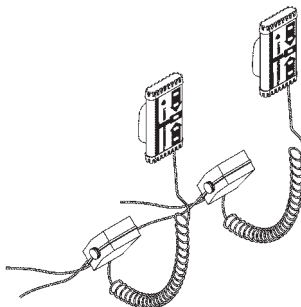

**Laser Control Package:**

- Control Panel Qty. 2
- 360° Sensor Qty. 2
- Power Cable Qty. 2
- Sensor Cable Qty. 2

**Features:**

- Manual override
- Consistently "On Grade"
- More accurate and efficient

**Order Code**  
Laser Alignment Controls(C) Qty. 2 of 000-200-054

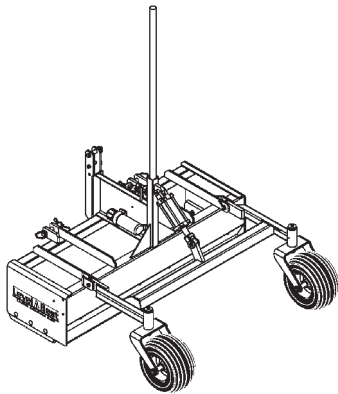

- Fine - grade finish
- Three-point hitch mount
- One cylinder controls depth

**SINGLE MODEL - TRACTOR**

**Manual Control:**

- Fine grading at a budget price
- Manual control

**Standard Features:**

- 1-1/2" Dia. Mast Pole
- Foam-filled Tires
- Powder Coated Finish
- Reversible Cutting Edge on all sides
- Category I & II hitch

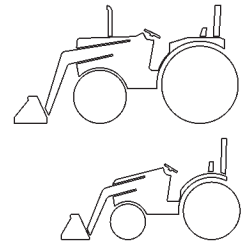

**Requirements:**

- Tractor-mounted power-beyond, or auxiliary hydraulic remote valve

**WITH CYLINDER (DOES NOT INCLUDE HYDRAULICS & LASER CONTROL PACKAGES)**

<u>Model</u>	<u>Box Width</u>	<u>Box Capacity</u>	<u>Recommended Tractor HP</u>	<u>Shipping Weight</u>	<u>Order Code</u>
LBS6	72"	17.0	30-42	985 lbs.	315-004-000
LBS7	84"	19.9	35-49	1045 lbs.	315-005-000
LBS8	96"	22.8	40-56	1105 lbs.	315-006-000

\* Price does not include hydraulics or laser controls. See Hydraulic and Laser Controls sections.



- Fine - grade finish
- Three-point hitch mount
- One cylinder controls depth

**COMPACT SINGLE MODEL - TRACTOR**

**Manual Control:**

- Fine grading at a budget price
- Manual control

**Standard Features:**

- 1-1/2" Dia. Mast Pole
- Flat-proof Tires
- Powder Coated Finish
- Reversible Cutting Edge on all sides
- Category I Quick hitch compatible

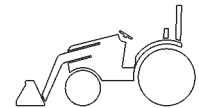

**Requirements:**

- Tractor-mounted power-beyond, or auxiliary hydraulic remote valve

**WITH CYLINDER (DOES NOT INCLUDE HYDRAULICS & LASER CONTROL PACKAGES)**

<u>Model</u>	<u>Box Width</u>	<u>Box Capacity</u>	<u>Recommended Tractor HP</u>	<u>Shipping Weight</u>	<u>Order Code</u>
SC48	48"	4.1	15-25	345 lbs.	315-070-000
SC54	54"	4.6	15-25	365 lbs.	315-071-000
SC60	60"	5.1	18-30	395 lbs.	315-072-000
SC66	66"	5.6	20-35	410 lbs.	315-073-000
SC72	72"	6.1	20-35	425 lbs.	315-074-000

\* Price does not include hydraulics or laser controls. See Hydraulic and Laser Controls sections.

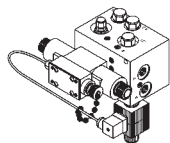

**HYDRAULIC VALVE PACKAGE for Laser Controls**

**Hydraulic Package:**

- Proportional Valve (Except Laser Alignment)
- Hoses & Fittings
- Solenoid Cable (Except Trimble)

**Features:**

- Machine control ready
- Laser controls added easily

**Hydraulics for:**

		<u>Order Code</u>
Laser Alignment	PT	000-166-241
Topcon (w/cables)	Proportional	000-166-448**
Trimble/Spectra	Proportional	000-166-483
Apache	Proportional	000-166-452
MEI/Mikrofynd	Proportional	000-166-407

**Cable Kits for:**

Trimble Controls	000-200-148
------------------	-------------

\*\* Note: Does not include sensor cable.

### LASER ALIGNMENT CONTROLS

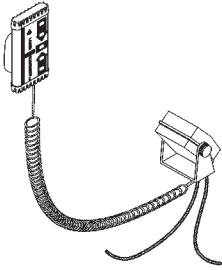

**Laser Control Package:**

- Control Panel
- 360° Sensor
- Power Cable
- Sensor Cable

**Features:**

- Manual override
- Consistently "On Grade"
- More accurate and efficient

Laser Alignment Controls(C)

**Order Code**  
000-200-054

### APACHE CONTROLS

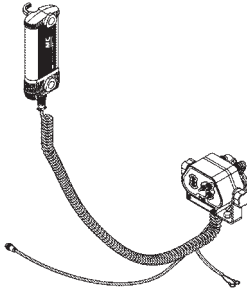

**Laser Control Package:**

- Control Panel
- 360° Sensor
- Power Cable
- Sensor Cable

**Features:**

- Manual override
- Consistently "On Grade"
- More accurate and efficient

Apache Controls(A)

**Order Code**  
000-200-095

### DRAWBAR OPTION - WITH WHEEL LOCKS

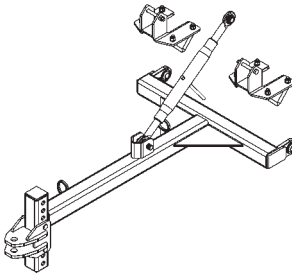

Box Type
SC Series
LBS/LBD Series - Single
LBS/LBD Series - Double

**Shipping Weight**

40 lbs.
100 lbs.
100 lbs.

**Order Code**

315-583-000
315-547-000
315-580-000

### "BULLET BAR" SCARIFIER BAR OPTION

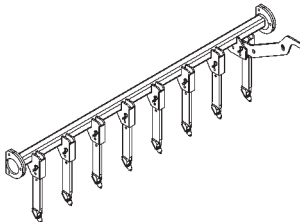

Type	Box Width
Manual	72"
Manual	84"
Manual	96"

**Shipping Weight**

230 lbs.
245 lbs.
265 lbs.

**Order Code**

315-538-000
315-539-000
315-540-000

Add for Factory Installation

### REAR HINGED CUTTING EDGE OPTION

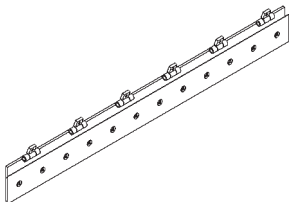

Box Width
72"
84"
96"

**Shipping Weight**

75 lbs.
80 lbs.
90 lbs.

**Order Code**

000-190-132
000-190-133
000-190-134

Add for Factory Installation

### BOGIE AXLE KIT FOR SC - SERIES BOX

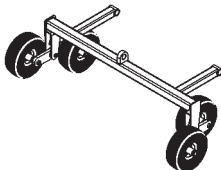

**Order Code**  
315-600-000

**SINGLE MODEL - SUPER-CAPACITY - TRACTOR**

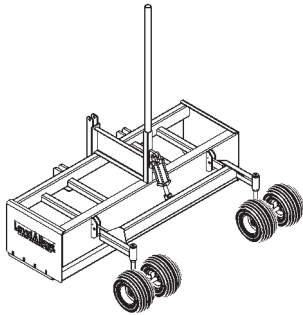

**Manual Control:**

- Fine grading at a budget price
- Manual control

**Standard Features:**

- 1-1/2" Dia. Mast Pole
- Dual-Wheel casters w/Foam-filled tires
- Powder Coated Finish
- Reversible Cutting Edge on all sides
- Category I & II hitch

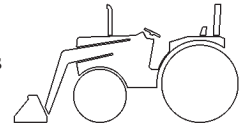

**Requirements:**

- Tractor-mounted power-beyond, or auxiliary hydraulic remote valve
- Two auxiliary hydraulic remote valves required for LBSE8 - 12

**WITH CYLINDER (DOES NOT INCLUDE HYDRAULICS & LASER CONTROL PACKAGES)**

- Fine - grade finish
- Three-point hitch mount
- One cylinder controls depth
- Higher & deeper box

<u>Model</u>	<u>Box Width</u>	<u>Box Capacity</u>	<u>Recommended Tractor HP</u>	<u>Shipping Weight</u>	<u>Order Code</u>
LBSE8	96"	37.5	70-90	1750 lbs.	315-064-000
LBSE9	108"	42.3	80-100	1835 lbs.	315-065-000
LBSE8-12	96"/144"	37.5/56.2	90-100	2445 lbs.	315-080-000

\* Price does not include hydraulics or laser controls. See Hydraulic and Laser Controls sections below.

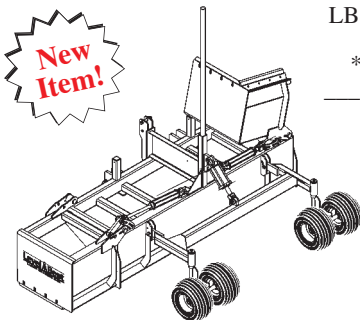

**LBSE8-12**

- Hydraulically folding wings extend width to 12'

**HYDRAULIC VALVE PACKAGE for Laser Controls**

**Hydraulic Package:**

- Proportional Valve (Except Laser Alignment)
- Hoses & Fittings
- Solenoid Cable (Except Trimble)

**Features:**

- Machine control ready
- Laser controls added easily

**Hydraulics for:**

	<b>Order Code</b>
<b>Laser Alignment</b>	000-166-293
<b>Topcon (w/cables)</b>	000-166-464**
<b>Apache</b>	000-166-462
<b>MEI/Mikrofynd</b>	000-166-463
<b>Trimble</b>	000-166-484

**Cable Kits for:**

<b>Trimble Controls</b>	000-200-148
-------------------------	-------------

\*\* Note: Does not include sensor cable.

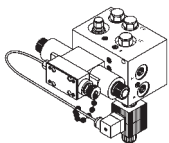

**LASER ALIGNMENT CONTROLS**

**Laser Control Package:**

- Control Panel
- 360° Sensor
- Power Cable
- Sensor Cable

**Features:**

- Manual override
- Consistently "On Grade"
- More accurate and efficient

	<b>Order Code</b>
<b>Laser Alignment Controls(C)</b>	000-200-054

**APACHE CONTROLS**

**Laser Control Package:**

- Control Panel
- 360° Sensor
- Power Cable
- Sensor Cable

**Features:**

- Manual override
- Consistently "On Grade"
- More accurate and efficient

	<b>Order Code</b>
<b>Apache Controls(A)</b>	000-200-095

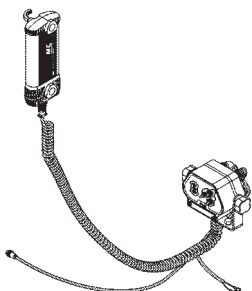
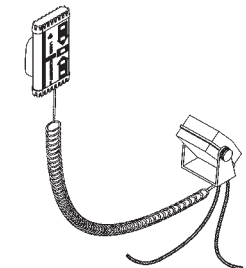

### DOUBLE MODEL - TRACTOR

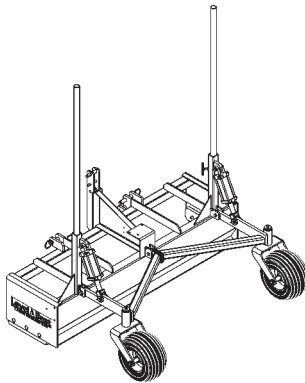

**Manual Control:**

- Fine grading at a budget price
- Manual control

**Standard Features:**

- Foam-filled Tires
- Powder Coated Finish
- Reversible Cutting Edge on all sides
- Category I & II hitch
- 1-1/2" Dia. Mast Pole Qty. 2

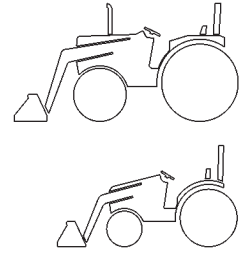

**Requirements:**

- Tractor-mounted power-beyond, or auxiliary hydraulic remote valve

<u>Model</u>	<u>Box Width</u>	<u>Box Capacity</u>	<u>Recommended Tractor HP</u>	<u>Shipping Weight</u>	<u>Order Code</u>
LBD6	72"	17.0	30-42	1115 lbs.	315-019-000
LBD7	84"	19.9	35-49	1135 lbs.	315-020-000
LBD8	96"	22.8	40-56	1165 lbs.	315-021-000

\* Price does not include any hydraulics & laser controls. See Hydraulic and Laser Controls sections below.

- Fine - grade finish
- Three-point hitch mount
- Two cylinders control depth
- Perfect for complex slopes

### HYDRAULIC VALVE PACKAGE for Laser Controls

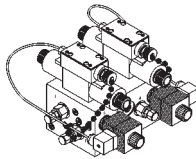

**Hydraulic Package:**

- Proportional Valve (Except Laser Alignment)
- Hoses & Fittings
- Solenoid Cable Qty. 2 (Except Trimble)

**Features:**

- Machine control ready
- Laser controls added easily

**Hydraulics for:**

		<u>Order Code</u>
Laser Alignment	PT	000-166-243
Topcon (w/cables)	Proportional	000-166-461**
Apache	Proportional	000-166-460
MEI/Mikrofyn	Proportional	000-166-438

\*\* Note: Does not include sensor cable.

### APACHE CONTROLS

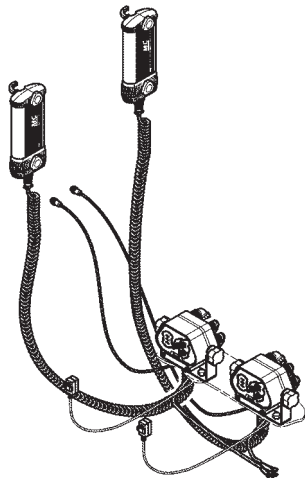

**Laser Control Package:**

- Control Panel Qty. 2
- 360° Sensor Qty. 2
- Power Cable Qty. 2
- Sensor Cable Qty. 2

**Features:**

- Manual override
- Consistently "On Grade"
- More accurate and efficient

	<u>Order Code</u>
Apache Controls(A) Qty 2 of	000-200-095

### LASER ALIGNMENT CONTROLS

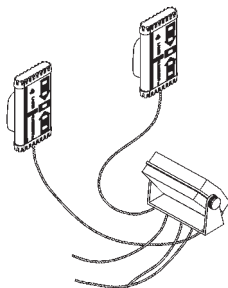

**Laser Control Package:**

- Control Panel Qty. 1
- 360° Sensor Qty. 2
- Power Cable Qty. 1
- Sensor Cable Qty. 2

**Features:**

- Manual override
- Consistently "On Grade"
- More accurate and efficient

	<u>Order Code</u>
Laser Alignment Controls(C)	000-200-056

Accessories can be found on Page 9.

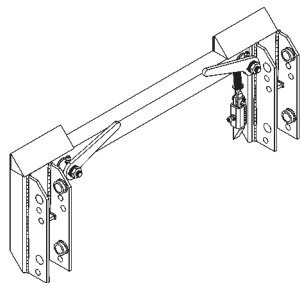

- Universal mount quick attach
- Change attachments in seconds
- Turns tractor loaders into tool carriers

## TACH-ALL QUICK ATTACH for TRACTOR LOADERS

- Makes tractor loaders compatible with universal mount skid steer attachments
- Two spring-loaded latching pins
- Heavy-duty construction
- Inexpensive ground shipment on most models

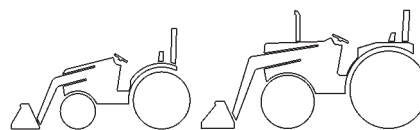

Model#	Fits Loader Model	Shipping	Order Code
		Weight	
<b><u>Cub Cadet / Woods</u></b>			
QA-CC1	Cub Cadet 476 & Woods 1009	78 lbs.	100-001-000
QA-CC2	Cub Cadet 417 & Woods 165	78 lbs.	100-022-000
QA-CC3	Cub Cadet 833	80 lbs.	100-078-000

Model#	Fits Loader Model	Shipping	Order Code
		Weight	
<b><u>Bush Hog / Great Bend</u></b>			
QA-BH1	Bush Hog 2240 & 2245	78 lbs.	100-053-000
QA-BH2	Bush Hog 2425, 2440 & 2445	88 lbs.	100-085-000
QA-GB1	Great Bend 240, 260 & 280	81 lbs.	100-020-000
QA-GB3	Great Bend 440 pin-on	86 lbs.	100-080-000
<b>New!</b> QA-GB4	Great Bend 660, 760, 770, 860, 870		100-099-000

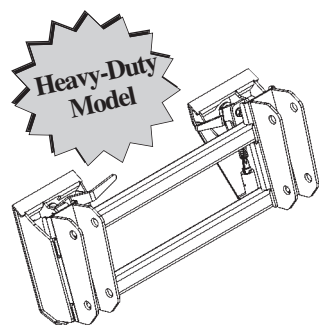

- Heavy duty Frame
- Universal mount quick attach
- Change attachments in seconds
- Turns tractor loaders into tool carriers

Model#	Fits Loader Model	Shipping	Order Code
		Weight	
<b><u>John Deere</u></b>			
QA-JD1	John Deere 80 Pin Type & 440 Pin Type	76 lbs.	100-011-000
QA-JD2	John Deere 300, 300X, 300CX, 400X, 400CX, 419, 420, 430, 440QA, - & 460 (JD QA)	80 lbs.	100-018-000
QA-JD3	John Deere 510, 512, 520, 521, 522, 540, 541 & 542 (JD QA)	106 lbs.	100-019-000
QA-JD4	John Deere 145, 146, 148 & 158	224 lbs.	100-067-000
QA-JD5	John Deere 70 & 70A	77 lbs.	100-030-000
QA-JD6	John Deere 620, 640, 720, 721, 725, 726, 740, 741 & 746	230 lbs.	100-068-000 <sup>1</sup>
QA-JD7	John Deere 245, 260 & 265 tractor loader	224 lbs.	100-069-000
QA-JD8	John Deere 840	277 lbs.	100-073-000
QA-JD9	John Deere 48	230 lbs.	100-077-000
QA-JD10	John Deere 100 & 175	162 lbs.	100-087-000



Model#	Fits Loader Model	Shipping	Order Code
		Weight	
<b><u>Kubota</u></b>			
QA-KU1	Kubota LA401, LA402, LA452, LA480, LA481, LA482, LA680, LA681, LA682, LB402, LB552 & LB702	76 lbs.	100-007-000
PK-KU1	Pin Kit for QA-KU1 & QA-KU6 (optional)	4 lbs.	000-161-062
QA-KU2	Kubota BF500, BF550, LA450, LA500, & LA650 (Includes: QA-KU1 & Pin Kit PK-KU1)	80 lbs.	100-008-000
QA-KU3	Kubota BF800, BF900, LA950, BF1100, LA950, LA1100 & LA1150 (Includes: QA-KU5 & Pin Kit PK-KU5)	94 lbs.	100-012-000
QA-KU4	Kubota TL720	95 lbs.	100-013-000
PK-KU4	Pin Kit for QA-KU4 & QA-KU9 (optional)	6 lbs.	000-161-063
QA-KU5	Kubota LA950A, LA1001, LA1002 & LA1150A	88 lbs.	100-014-000
PK-KU5	Pin Kit for QA-KU5 & QA-KU7 (optional)	6 lbs.	000-161-064
QA-KU6	Kubota TL420 & TL421	76 lbs.	100-015-000
QA-KU7	Kubota LA1251	124 lbs.	100-016-000
QA-KU8	Kubota TL1150 & LA1162	125 lbs.	100-064-000
QA-KU9	Kubota LA852	81 lbs.	100-025-000
QA-KU10	Kubota M1000	81 lbs.	100-032-000
QA-KU11	Kubota LA463 & LA513	78 lbs.	100-059-000
QA-KU12	Kubota LA723	80 lbs.	100-060-000
QA-KU13	Kubota LA853	81 lbs.	100-061-000
QA-KU14	Kubota LA1301, LA1601 & LA1251 w/Kubota QA	260 lbs.	100-072-000
QA-KU15	Kubota LA403	78 lbs.	100-076-000
QA-KU16	Kubota LA703	81 lbs.	100-082-000
<b>New!</b> QA-KX161	Kubota KX161-3 Mini-Excavator	230 lbs.	100-091-000

Model#	Fits Loader Model	Shipping	Order Code
		Weight	
<b><u>Massey Ferguson / AGCO / Challenger</u></b>			
QA-MF1	Massey Ferguson 1246, & 1466, AGCO SL46, Challenger & ML30, TYM TL100 & TL200	84 lbs.	100-021-000
QA-MF2	Massey Ferguson 232, 236, 832, 932, 1040 & 1050 AGCO SL48 & Challenger ML40, AGCO 656	101 lbs.	100-006-000
QA-MF3	Massey Ferguson 1244, 1464, AGCO SL44 & Challenger ML20	84 lbs.	100-088-000
<b>New!</b> QA-AC1	Allis Chalmers 400, 450, 460, 500		100-095-000

## Tach-All™ Quick Attach for Tractor Loaders

### TACH-ALL QUICK ATTACH for TRACTOR LOADERS

- Makes tractor loaders compatible with universal mount skid steer attachments
- Two spring-loaded latching pins
- Heavy-duty construction
- Inexpensive ground shipment on most models

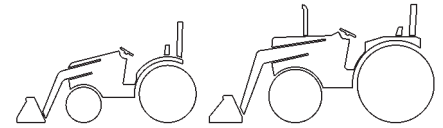

**Shipping**

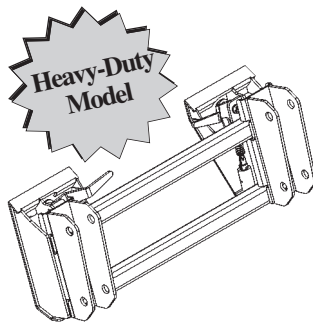

**Heavy-Duty Model**

Model#	Fits Loader Model	Weight	Order Code
<b><u>New Holland / Case IH</u></b>			
QA-FO1	New Holland 7108 & 7308 & Case IH L130	76 lbs.	100-009-000
QA-FO2	New Holland 2109, 7109, 7209, 7210, 7309, 7310 & 7410	117 lbs.	100-010-000
QA-FO3	New Holland 14LA, 15LA, 16LA, 17LA, 18LA & Case IH L160, LX114, LX116 & LX118	100 lbs.	100-026-000
QA-FO4	Ford 770, 770A & 770B	80 lbs.	100-002-000
QA-FO5	Ford 345C & 345D	193 lbs.	100-070-000
QA-FO6	Ford 445C, 445D, 545C & 545D	194 lbs.	100-071-000
QA-FO7	Ford 712, 720, 725, 730 & 735 loaders	194 lbs.	100-079-000
QA-FO8	Ford 740 loader	196 lbs.	100-081-000
QA-FO9	Ford 771, Kubota 1500, Schwartz 1200HD, 1350 & 1450	85 lbs.	100-086-000
QA-FO10	Ford 776A, 776B, 777B, 777D & 777E	207 lbs.	100-089-000
<b>New!</b> QA-FO11	Ford 745	201 lbs.	100-092-000
<b>New!</b> QA-FO12	Ford 772, Schwartz 1300 & 1400	196 lbs.	100-093-000
<b>New!</b> QA-FO13	New Holland 7614 (TV140)	240 lbs.	100-097-000
QA-CA1	Case IH 2250 & 2255	93 lbs.	100-017-000
QA-CA2	Case IH 2050	108 lbs.	100-027-000
QA-CA3	Case IH 2000	108 lbs.	100-033-000
QA-CA4	Case IH 10QA & L108 (Pins included)	76 lbs.	100-054-000
<b>New!</b> QA-CA5	Case IH 1850, 2200	198 lbs.	100-101-000

<sup>1</sup> Requires John Deere latch kit #BW15085 or ATI Corporation P/N 001-001-068.

**Misc**

QA-ALO	Alo/Quicke Quick Attach	223 lbs.	100-084-000
QA-ASV	ASV RC30 & Polaris ALS300	105 lbs.	100-055-000
QA-HD	Blank Frame, Heavy-Duty w/o mounting brackets	130 lbs.	100-074-000
QA-KM1	Kioti KL1450 & KL1470	85 lbs.	100-057-000
QA-KM2	Kioti KL120 & KL130	87 lbs.	100-065-000
QA-KM3	Kioti KL1231	87 lbs.	100-066-000
QA-LO1	Long 5140 & 5140M (Pins Included)	79 lbs.	100-062-000
QA-ML1	Mahindra ML108 & ML112	80 lbs.	100-083-000

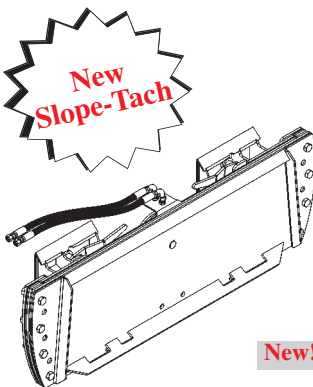

**New Slope-Tach**

### SLOPE-TACH for SKID STEER LOADERS

- Slopes attachments up to 17-degrees in either direction
- Cut grades, ditches or swales with skid steer
- Keep attachment level on hilly ground
- Dual cylinders provide smooth operation and greater tilting force



Model#	Type	Shipping Weight	Order Code
<b>New!</b> QA-SP1	Slope-Tach, Universal Mount	415 lbs.	100-094-000

### THREE-POINT HITCH UNIVERSAL-MOUNT QUICK ATTACH

- Use universal-mount skid steer attachments on tractor three-point hitch
- Functions best with hydraulic top link
- Fits any tractor with Cat. 1 three-point hitch

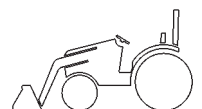

Model#	Type	Shipping Weight	Order Code
QA-3PT	Three-Point Quick Attach Cat. 1	106 lbs.	100-028-000

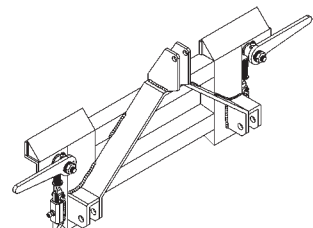

- Use Universal Mount attachments on tractor three-point
- Pins on tractor three-point hitch

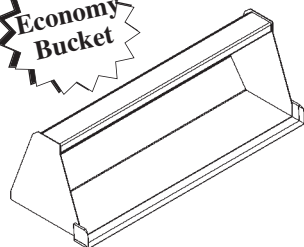

- For General purpose applications
- For loaders up to 1000 lbs. lift capacity

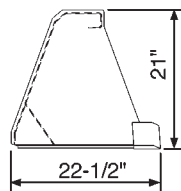

**Bucket Capacity-Cubic Foot**

Series-100	Struck	Heaped
<b>148</b>	6.8	8.1
<b>154</b>	7.7	9.1
<b>160</b>	8.5	10.1
<b>166</b>	9.4	11.2

## SERIES-100 UTILITY BUCKETS for COMPACT TRACTOR LOADERS

- Economical bucket for loaders w/ lift capacities up to 1000 lbs.
- Made to fit numerous quick attach or 4-pin compact tractor loaders
- Flat top design for use as level indicator
- Square heel aids back grading
- Color choices: Kubota orange, John Deere green, satin black



Type	Model	Weight	Attachment	Order Code
48" Utility Bucket	<b>148</b>	175 lbs.	4-pin or QA	402-019-000
			Skid steer type QA	401-049-000
54" Utility Bucket	<b>154</b>	190 lbs.	4-pin or QA	402-020-000
			Skid steer type QA	401-050-000
60" Utility Bucket	<b>160</b>	215 lbs.	4-pin or QA	402-021-000
			Skid steer type QA	401-051-000
66" Utility Bucket	<b>166</b>	240 lbs.	4-pin or QA	402-022-000
			Skid steer type QA	401-052-000

## SERIES-200 UTILITY BUCKETS for COMPACT TRACTOR LOADERS

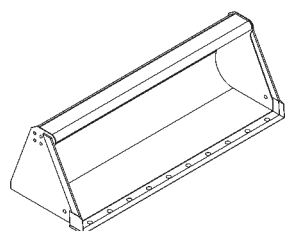

- For General purpose applications
- Pre-drilled for cutting edge, tooth bar, or grapple kit
- For loaders up to 1500 lbs. lift capacity

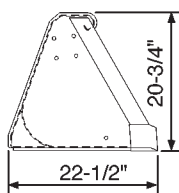

**Bucket Capacity-Cubic Foot**

Series-200	Struck	Heaped
<b>248</b>	7.2	8.5
<b>254</b>	8.1	9.6
<b>260</b>	9.0	10.7
<b>266</b>	9.9	11.8
<b>272</b>	10.8	12.9

- Premium bucket for loaders w/ lift capacities up to 1500 lbs
- Made to fit numerous quick attach or 4-pin compact tractor loaders
- Round Back for easy clean-out
- Flat top design for use as level indicator
- Square heel aids back grading
- Pre-drilled holes for optional accessories: Bolt-on cutting edge, tooth bar, grapple kit
- Color choices: Kubota orange, John Deere green, satin black



Type	Model	Weight	Attachment	Order Code
48" Utility Bucket	<b>248</b>	200 lbs.	4-pin or QA	402-000-000
			Skid steer type QA	401-053-000
54" Utility Bucket	<b>254</b>	225 lbs.	4-pin or QA	402-001-000
			Skid steer type QA	401-054-000
60" Utility Bucket	<b>260</b>	250 lbs.	4-pin or QA	402-002-000
			Skid steer type QA	401-004-000
66" Utility Bucket	<b>266</b>	275 lbs.	4-pin or QA	402-003-000
			Skid steer type QA	401-005-000
72" Utility Bucket	<b>272</b>	300 lbs.	4-pin or QA	402-004-000
			Skid steer type QA	401-006-000

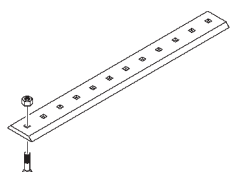

**Bolt-on Cutting Edge for Series 200 & 300 buckets**

1/2" x 6" x 48" Bolt-on edge & hardware	000-190-103
1/2" x 6" x 54" Bolt-on edge & hardware	000-190-104
1/2" x 6" x 60" Bolt-on edge & hardware	000-190-105
1/2" x 6" x 66" Bolt-on edge & hardware	000-190-106
1/2" x 6" x 72" Bolt-on edge & hardware	000-190-107

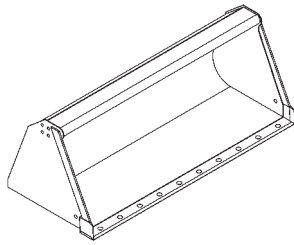

### **SERIES-300 HIGH CAPACITY BUCKETS for COMPACT TRACTOR LOADERS**

- Premium, high capacity bucket for loaders w/ lift capacities up to 1500 lbs.
- Ideal for snow, mulch, sawdust, and other low density materials
- Made to fit numerous quick attach or 4-pin compact tractor loaders
- Round Back for easy clean-out
- Flat top design for use as level indicator
- Square heel aids back grading
- Pre-drilled holes for optional accessories: Bolt-on cutting edge, tooth bar, grapple kit
- Color choices: Kubota orange, John Deere green, satin black

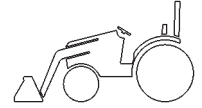

- High capacity bucket is higher & deeper
- Pre-drilled for cutting edge, tooth bar, or grapple kit
- For loaders up to 1500 lbs. lift capacity

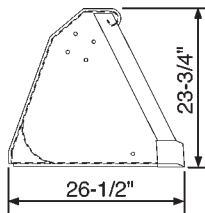

Type	Model	Weight	Attachment	Order Code
48" High Capacity Bucket	<b>348</b>	220 lbs.	4-pin or QA	402-005-000
			Skid steer type QA	401-055-000
54" High Capacity Bucket	<b>354</b>	245 lbs.	4-pin or QA	402-006-000
			Skid steer type QA	401-056-000
60" High Capacity Bucket	<b>360</b>	270 lbs.	4-pin or QA	402-007-000
			Skid steer type QA	401-007-000
66" High Capacity Bucket	<b>366</b>	295 lbs.	4-pin or QA	402-008-000
			Skid steer type QA	401-008-000
72" High Capacity Bucket	<b>372</b>	320 lbs.	4-pin or QA	402-009-000
			Skid steer type QA	401-009-000

#### **Bucket Capacity-Cubic Foot**

Series-300	Struck	Heaped
<b>348</b>	10.3	11.9
<b>354</b>	11.6	13.5
<b>360</b>	12.8	15.0
<b>366</b>	14.1	16.5
<b>372</b>	15.4	18.1

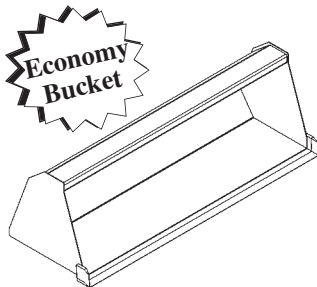

### **SERIES-400 UTILITY BUCKETS for TRACTOR LOADERS**

- Economical bucket for loaders w/ lift capacities up to 2000 lbs.
- Made to fit numerous quick attach or 4-pin tractor loaders
- Flat top design for use as level indicator
- Square heel aids back grading
- Color choices: Kubota orange, John Deere green, satin black

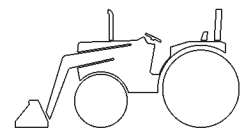

- For General purpose applications
- For loaders up to 2000 lbs. lift capacity

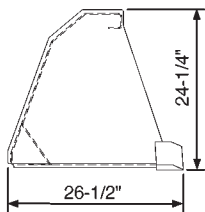

Type	Model	Weight	Attachment	Order Code
60" Utility Bucket	<b>460</b>	365 lbs.	4-pin or QA	402-023-000
			Skid steer type QA	401-057-000
66" Utility Bucket	<b>466</b>	390 lbs.	4-pin or QA	402-024-000
			Skid steer type QA	401-059-000
72" Utility Bucket	<b>472</b>	415 lbs.	4-pin or QA	402-025-000
			Skid steer type QA	401-060-000
78" Utility Bucket	<b>478</b>	440 lbs.	4-pin or QA	402-026-000
			Skid steer type QA	401-061-000
84" Utility Bucket	<b>484</b>	465 lbs.	4-pin or QA	402-027-000
			Skid steer type QA	401-062-000

#### **Bucket Capacity-Cubic Foot**

Series-400	Struck	Heaped
<b>460</b>	12.0	14.1
<b>466</b>	13.2	15.6
<b>472</b>	14.4	17.0
<b>478</b>	15.6	18.4
<b>484</b>	16.8	19.9

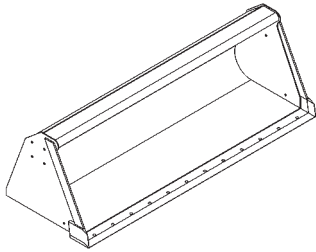

## SERIES-500 UTILITY BUCKETS for TRACTOR LOADERS

- Premium bucket for loaders w/ lift capacities up to 3000 lbs.
- Made to fit numerous quick attach or 4-pin compact tractor loaders
- Round Back for easy clean-out
- Flat top design for use as level indicator
- Square heel aids back grading
- Pre-drilled holes for optional accessories: Bolt-on cutting edge, tooth bar, grapple kit
- Color choices: Kubota orange, John Deere green, satin black

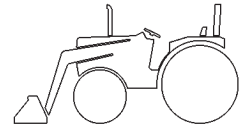

- For General purpose applications
- Pre-drilled for cutting edge, tooth bar, or grapple kit
- For loaders up to 3000 lbs. lift capacity

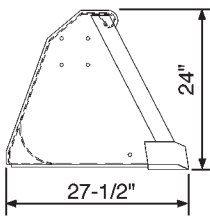

Type	Model	Weight	Attachment	Order Code
60" Utility Bucket	<b>560</b>	410 lbs.	4-pin or QA	402-028-000
			Skid steer type QA	401-058-000
66" Utility Bucket	<b>566</b>	440 lbs.	4-pin or QA	402-029-000
			Skid steer type QA	401-036-000
72" Utility Bucket	<b>572</b>	495 lbs.	4-pin or QA	402-030-000
			Skid steer type QA	401-037-000
78" Utility Bucket	<b>578</b>	520 lbs.	4-pin or QA	402-031-000
			Skid steer type QA	401-038-000
84" Utility Bucket	<b>584</b>	550 lbs.	4-pin or QA	402-032-000
			Skid steer type QA	401-039-000

### Bucket Capacity-Cubic Foot

Series-500	Struck	Heaped
<b>560</b>	13.0	15.2
<b>566</b>	14.2	16.8
<b>572</b>	15.5	18.4
<b>578</b>	16.8	19.9
<b>584</b>	18.1	21.5

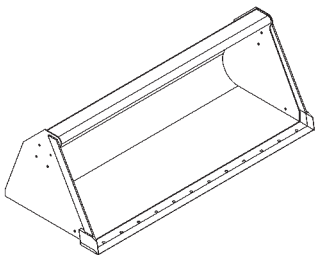

## SERIES-600 HIGH CAPACITY BUCKETS for TRACTOR LOADERS

- Premium, high capacity bucket for loaders w/ lift capacities up to 3000 lbs.
- Ideal for snow, mulch, sawdust, and other low density materials
- Made to fit numerous quick attach or 4-pin compact tractor loaders
- Round Back for easy clean-out
- Flat top design for use as level indicator
- Square heel aids back grading
- Pre-drilled holes for optional accessories: Bolt-on cutting edge, tooth bar, grapple kit
- Color choices: Kubota orange, John Deere green, satin black

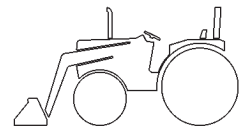

- High capacity bucket is higher & deeper
- Pre-drilled for cutting edge, tooth bar, or grapple kit

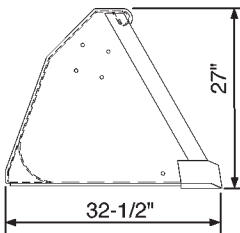

Type	Model	Weight	Attachment	Order Code
60" High Capacity Bucket	<b>660</b>	465 lbs.	4-pin or QA	402-033-000
			Skid steer type QA	401-063-000
66" High Capacity Bucket	<b>666</b>	495 lbs.	4-pin or QA	402-034-000
			Skid steer type QA	401-064-000
72" High Capacity Bucket	<b>672</b>	535 lbs.	4-pin or QA	402-035-000
			Skid steer type QA	401-065-000
78" High Capacity Bucket	<b>678</b>	570 lbs.	4-pin or QA	402-036-000
			Skid steer type QA	401-066-000
84" High Capacity Bucket	<b>684</b>	600 lbs.	4-pin or QA	402-037-000
			Skid steer type QA	401-067-000

### Bucket Capacity-Cubic Foot

Series-600	Struck	Heaped
<b>660</b>	17.2	20.3
<b>666</b>	19.0	22.3
<b>672</b>	20.7	24.4
<b>678</b>	22.4	26.5
<b>684</b>	24.1	28.6

### Bolt-on Cutting Edge for Series 500, 600, 700 & 800 buckets

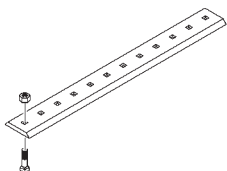

5/8" x 6" x 60" Bolt-on edge & hardware	000-190-135
5/8" x 6" x 66" Bolt-on edge & hardware	000-190-136
5/8" x 6" x 72" Bolt-on edge & hardware	000-190-137
5/8" x 6" x 78" Bolt-on edge & hardware	000-190-138
5/8" x 6" x 84" Bolt-on edge & hardware	000-190-139
5/8" x 6" x 90" Bolt-on edge & hardware	000-190-140
5/8" x 6" x 96" Bolt-on edge & hardware	000-190-141
5/8" x 6" x 102" Bolt-on edge & hardware	000-190-142

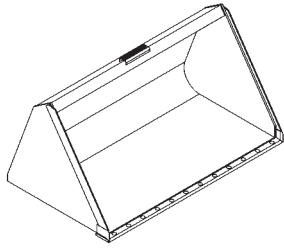

### **SERIES-700 UNIVERSAL MOUNT UTILITY BUCKETS** *for SKID STEER LOADERS*

- Heavy-duty bucket for Universal mount skid steer loaders
- Round Back for easy clean-out
- Two, tubular torsion members for durability
- Square heel aids back grading
- Pre-drilled holes for optional Bolt-on cutting edge
- Color choices: Satin black or Case Power Tan



- Universal Quick Attach
- For General Purpose Usage

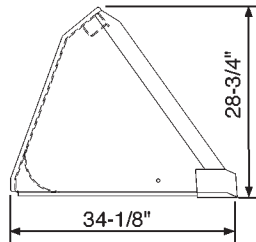

Type	Model	Weight	Attachment	Order Code
60" Utility Bucket	<b>760</b>	525 lbs.	Universal Mount QA	401-010-000
66" Utility Bucket	<b>766</b>	560 lbs.	Universal Mount QA	401-011-000
72" Utility Bucket	<b>772</b>	595 lbs.	Universal Mount QA	401-012-000
78" Utility Bucket	<b>778</b>	630 lbs.	Universal Mount QA	401-013-000
84" Utility Bucket	<b>784</b>	660 lbs.	Universal Mount QA	401-014-000
90" Utility Bucket	<b>790</b>	675 lbs.	Universal Mount QA	401-015-000
96" Utility Bucket	<b>796</b>	690 lbs.	Universal Mount QA	401-016-000
102" Utility Bucket	<b>7102</b>	710 lbs.	Universal Mount QA	401-017-000

#### **Bucket Capacity-Cubic Foot**

Series-700	Struck	Heaped
<b>760</b>	16.4	20.1
<b>766</b>	18.1	22.2
<b>772</b>	19.7	24.3
<b>778</b>	21.4	26.4
<b>784</b>	23.0	28.5
<b>790</b>	24.6	30.6
<b>796</b>	26.3	32.7
<b>7102</b>	28.0	34.8

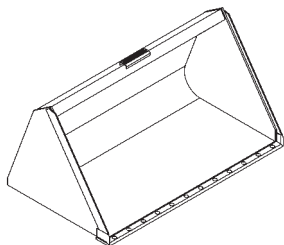

### **SERIES-800 UNIVERSAL MOUNT HIGH CAPACITY BUCKETS** *for SKID STEER LOADERS*

- High capacity bucket for Universal mount skid steer loaders
- Round Back for easy clean-out
- Two, tubular torsion members for durability
- Square heel aids back grading
- Pre-drilled holes for optional Bolt-on cutting edge
- Color choices: Satin black or Case Power Tan



- Universal Quick Attach
- High capacity bucket is higher & deeper

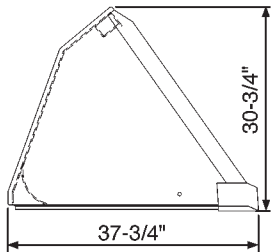

Type	Model	Weight	Attachment	Order Code
60" High Capacity Bucket	<b>860</b>	540 lbs.	Universal Mount QA	401-020-000
66" High Capacity Bucket	<b>866</b>	575 lbs.	Universal Mount QA	401-021-000
72" High Capacity Bucket	<b>872</b>	610 lbs.	Universal Mount QA	401-022-000
78" High Capacity Bucket	<b>878</b>	645 lbs.	Universal Mount QA	401-023-000
84" High Capacity Bucket	<b>884</b>	675 lbs.	Universal Mount QA	401-024-000
90" High Capacity Bucket	<b>890</b>	690 lbs.	Universal Mount QA	401-025-000
96" High Capacity Bucket	<b>896</b>	770 lbs.	Universal Mount QA	401-026-000
102" High Capacity Bucket	<b>8102</b>	790 lbs.	Universal Mount QA	401-027-000

#### **Bucket Capacity-Cubic Foot**

Series-800	Struck	Heaped
<b>860</b>	20.0	24.2
<b>866</b>	22.0	26.7
<b>872</b>	24.0	29.3
<b>878</b>	26.0	31.8
<b>884</b>	28.0	34.3
<b>890</b>	30.0	36.8
<b>896</b>	32.0	39.4
<b>8102</b>	34.0	41.8

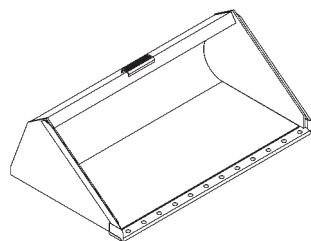

- Universal Quick Attach
- Low Profile Design for visibility

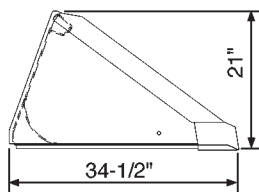

## SERIES-900 UNIVERSAL MOUNT LOW-PROFILE BUCKETS for SKID STEER LOADERS

- Industrial-strength bucket for Universal mount skid steer loaders
- Low-profile design provides visibility of cutting edge
- Round Back for easy clean-out
- Two, tubular torsion members for durability
- Square heel aids back grading
- Pre-drilled holes for optional Bolt-on cutting edge
- Color choices: Satin black or Case Power Tan



Type	Model	Weight	Attachment	Order Code
60" Low-Profile Bucket	<b>960</b>	485 lbs.	Universal Mount QA	401-030-000
66" Low-Profile Bucket	<b>966</b>	510 lbs.	Universal Mount QA	401-031-000
72" Low-Profile Bucket	<b>972</b>	540 lbs.	Universal Mount QA	401-032-000
78" Low-Profile Bucket	<b>978</b>	575 lbs.	Universal Mount QA	401-033-000
84" Low-Profile Bucket	<b>984</b>	610 lbs.	Universal Mount QA	401-034-000

### Bucket Capacity-Cubic Foot

Series-900	Struck	Heaped
<b>960</b>	12.7	15.7
<b>966</b>	14.0	17.4
<b>972</b>	15.3	19.0
<b>978</b>	16.6	20.6
<b>984</b>	17.8	22.2

### Bolt-on Cutting Edge for Series 900 buckets

5/8" x 6" x 60" Bolt-on edge & hardware	000-190-135
5/8" x 6" x 66" Bolt-on edge & hardware	000-190-136
5/8" x 6" x 72" Bolt-on edge & hardware	000-190-137
5/8" x 6" x 78" Bolt-on edge & hardware	000-190-138
5/8" x 6" x 84" Bolt-on edge & hardware	000-190-139
5/8" x 6" x 90" Bolt-on edge & hardware	000-190-140
5/8" x 6" x 96" Bolt-on edge & hardware	000-190-141
5/8" x 6" x 102" Bolt-on edge & hardware	000-190-142

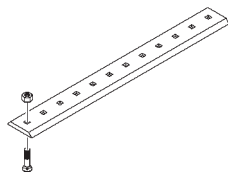

## 4-in-1 BUCKET for TRACTOR LOADERS

- Dig, grapple, doze, and back drag with one versatile bucket
- Pre-drilled cutting edge accepts bolt-on edge
- Bucket comes fully plumbed with jumper hoses

**Note:** Dealer must furnish quick couplers. Tractor must be equipped with third function valve.



Type	Cutting Edge	Heaped Cap. Ft. <sup>3</sup>	Approx. Weight	Order Code
54" LD4-54 4-in-1 Bucket*	1/2" x 4"	8.8	325 lbs.	311-022-000
60" LD4-60 4-in-1 Bucket*	1/2" x 4"	9.8	350 lbs.	311-020-000
66" LD4-66 4-in-1 Bucket*	1/2" x 4"	10.8	375 lbs.	311-021-000
66" MD4-66 4-in-1 Bucket	3/4" x 6"	12.1	570 lbs.	311-013-000
72" MD4-72 4-in-1 Bucket	3/4" x 6"	13.2	608 lbs.	311-014-000
78" MD4-78 4-in-1 Bucket	3/4" x 6"	14.3	645 lbs.	311-015-000

\* Recommend for compact tractor loaders up to 1200 lbs.

- Versatile bucket sized for compact tractors
- Five widths -54", 60", 66", 72" & 78"



### Bolt-on Cutting Edge for 4-in-1 buckets

1/2" x 6" x 54" Bolt-on edge & hardware	000-190-104
1/2" x 6" x 60" Bolt-on edge & hardware	000-190-105
1/2" x 6" x 66" Bolt-on edge & hardware	000-190-106
5/8" x 6" x 66" Bolt-on edge & hardware	000-190-136
5/8" x 6" x 72" Bolt-on edge & hardware	000-190-137
5/8" x 6" x 78" Bolt-on edge & hardware	000-190-138

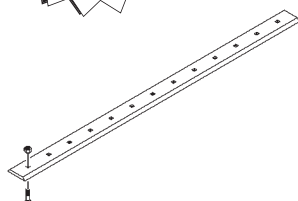

### UTILITY BUCKETS - CUSTOM-BUILT

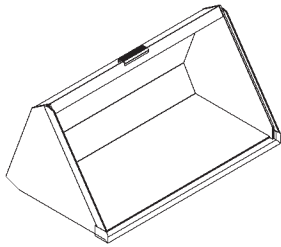

- Heavy-duty construction
- Reinforced end sheets
- Abrasion resistant cutting edge
- 3/4" Cutting edge
- 7-gauge (3/16") sheet

- Custom-built like original equipment bucket
- Pin type or quick attach mount
- General purpose usage

Type	Cutting Edge	No. Skids	Approx. Weight	Order Code
60" Utility - Custom Built	3/4" x 4"	3	395 lbs.	400-001-000
66" Utility - Custom Built	3/4" x 4"	3	415 lbs.	400-002-000
72" Utility - Custom Built	3/4" x 4"	4	460 lbs.	400-003-000
78" Utility - Custom Built	3/4" x 4"	4	475 lbs.	400-004-000
84" Utility - Custom Built	3/4" x 6"	5	505 lbs.	400-005-000
90" Utility - Custom Built	3/4" x 6"	5	530 lbs.	400-006-000
96" Utility - Custom Built	3/4" x 6"	6	570 lbs.	400-007-000
102" Utility - Custom Built	3/4" x 6"	7	680 lbs.	400-008-000

### HIGH CAPACITY BUCKETS - CUSTOM-BUILT

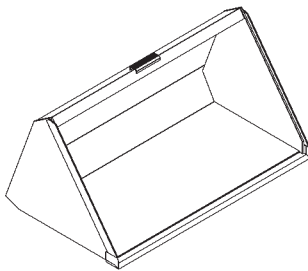

- Extra capacity for light-weight, bulky materials (saw dust, silage)
- Higher and deeper than utility bucket
- Same rugged construction as utility bucket
- 3/4" Cutting edge
- 7-gauge (3/16") sheet

- Custom-built like original equipment bucket
- Pin type or quick attach mount
- Higher & deeper for lighter materials

Type	Cutting Edge	No. Skids	Approx. Weight	Order Code
60" High Capacity - Custom Built	3/4" x 4"	3	415 lbs.	400-010-000
66" High Capacity - Custom Built	3/4" x 4"	4	440 lbs.	400-011-000
72" High Capacity - Custom Built	3/4" x 4"	4	485 lbs.	400-012-000
78" High Capacity - Custom Built	3/4" x 4"	5	505 lbs.	400-013-000
84" High Capacity - Custom Built	3/4" x 6"	5	535 lbs.	400-014-000
90" High Capacity - Custom Built	3/4" x 6"	6	570 lbs.	400-015-000
96" High Capacity - Custom Built	3/4" x 6"	6	605 lbs.	400-016-000
102" High Capacity - Custom Built	3/4" x 6"	7	715 lbs.	400-017-000

### DIRT BUCKETS - CUSTOM-BUILT

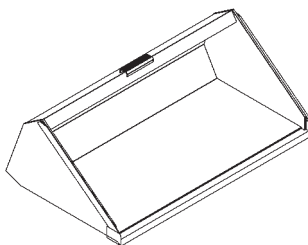

- Industrial-strength bucket
- 1/2" x 3" Cutting edge on end sheets
- 3/4" Cutting edge
- Low profile for visibility
- Additional skid for long wear
- 7-gauge (3/16") sheet

- Custom-built like original equipment bucket
- Pin type or quick attach mount
- Industrial-strength

Type	Cutting Edge	No. Skids	Approx. Weight	Order Code
60" Dirt - Custom Built	3/4" x 4"	4	385 lbs.	400-020-000
66" Dirt - Custom Built	3/4" x 6"	4	410 lbs.	400-021-000
72" Dirt - Custom Built	3/4" x 6"	5	440 lbs.	400-022-000
78" Dirt - Custom Built	3/4" x 6"	5	475 lbs.	400-023-000
84" Dirt - Custom Built	3/4" x 6"	6	510 lbs.	400-024-000

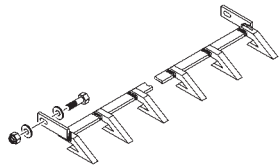

## TOOTH BARS

- Sized perfectly for compact tractors
- Standard or replacement teeth are available
- Available for buckets with 3/8" or 1/2" cutting edge
- Mounting hardware and instructions included
- Inexpensive ground shipment available

### Standard Tooth

- Low-cost bar for light to moderate use

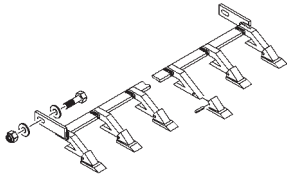

### Replaceable Tooth

- For commercial or high use applications
- 2A points are pinned in place



## Kubota

Bucket #	Bucket Type	Bucket Inside Dim.		
B1614	48" Bucket for LA272, LA302	46-1/2"		
BX1618	48" Bucket for LA211, LA181	46-1/2"		
BX2344	48" Bucket for LA203	46-1/2"		
BX2354	48" Bucket for LA240, LA243	46-1/2"		
Tooth Bar Type	Model #	# of Teeth	Weight	Order Code
Standard Tooth	TBC-6J	6	39 lbs.	303-012-000
Replaceable Tooth	TBC-6JR	6	44 lbs.	303-013-000

Bucket #	Bucket Type	Bucket Inside Dim.		
B1615	50" Bucket for LA352	48-1/2"		
Tooth Bar Type	Model #	# of Teeth	Weight	Order Code
Standard Tooth	TBC-6K	6	39 lbs.	303-014-000
Replaceable Tooth	TBC-6KR	6	45 lbs.	303-015-000

Bucket #	Bucket Type	Bucket Inside Dim.		
B1616	54" Material Bucket for LA402	52-1/4"		
B2345	54" Material Bucket for LA403	52-1/4"		
Tooth Bar Type	Model #	# of Teeth	Weight	Order Code
Standard Tooth	TBC-7O	7	47 lbs.	303-032-000
Replaceable Tooth	TBC-7OR	7	54 lbs.	303-033-000

Bucket #	Bucket Type	Bucket Inside Dim.		
B1617	60" Light Material Bucket for LA402	58-1/2"		
B2355	60" Light Material Bucket for LB403	58-1/2"		
Tooth bar also fits: L1740A, L1741A, L1742A, L1743A, LA1746A				
Tooth Bar Type	Model #	# of Teeth	Weight	Order Code
Standard Tooth	TBC-7A	7	47 lbs.	303-020-000
Replaceable Tooth	TBC-7AR	7	54 lbs.	303-021-000

Bucket #	Bucket Type	Bucket Inside Dim.		
L1701	66" Buckets for LA463	64-1/2"		
L2243	66" Buckets for LA513	64-1/2"		
L2234	66" Buckets for LA513	64-1/2"		
L2253	66" Buckets for LA513	64-1/2"		
L2239	66" Buckets for LA513	64-1/2"		
Tooth bar also fits: L1780, L1790				
Tooth Bar Type	Model #	# of Teeth	Weight	Order Code
Standard Tooth	TBC-8P	8	52 lbs.	303-046-000
Replaceable Tooth	TBC-8PR	8	60 lbs.	303-047-000

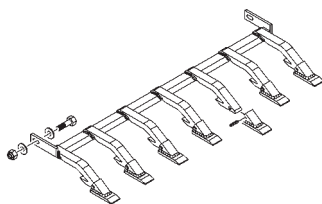

- Heavy Duty specs for Skid Steer & larger Tractor Loaders
- Series 23 teeth pinned in place
- May be ordered to fit over a bolt on cutting edge

Bucket #	Bucket Type	Bucket Inside Dim.	Edge	
M1047	72" Bucket for LA1002	70-1/2"	3/4"	
M1282	72" Bucket, Pin On for LA1251	70-1/2"	3/4"	
M1283	72" Bucket, Quick Attach for LA1251	70-1/2"	3/4"	
TL1746	72" Bucket for TL1150, LA1162	70-1/2"	3/4"	
TL1747	72" Round Back Bucket for LA1162	70-1/2"	3/4"	
L2235	72" Bucket for Grand L Kubota Loaders	70-1/2"	3/4"	
L2283	72" Bucket for Grand L Kubota Loaders	70-1/2"	3/4"	
L2263	72" Bucket for Grand L Kubota Loaders	70-1/2"	3/4"	
L2273	72" Bucket for Grand L Kubota Loaders	70-1/2"	3/4"	
L2240	72" Bucket for Grand L Kubota Loaders	70-1/2"	3/4"	
L2293	72" Bucket for Grand L Kubota Loaders	70-1/2"	3/4"	
Tooth bar also fits: L1769, L1779				
Tooth Bar Type	Model #	# of Teeth	Weight	Order Code
HD Replaceable Tooth	TB-7HDR	7	130 lbs.	303-071-000

## Tooth Bars for Compact Tractors

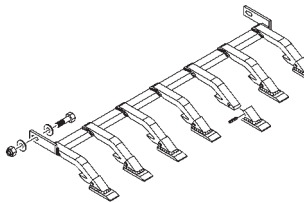

### TOOTH BARS (continued)

- Sized perfectly for compact tractors
- Standard or replacement teeth are available
- Available for buckets with 3/8" or 1/2" cutting edge
- Mounting hardware and instructions included
- Inexpensive ground shipment available

- Heavy Duty specs for Skid Steer & larger Tractor Loaders
- Series 23 teeth pinned in place
- May be ordered to fit over a bolt on cutting edge

### Kubota

Bucket #	Bucket Type			Bucket Inside Dim.	Edge Thickness
M1284	84" Bucket for LA1251			82-1/2"	3/4"
Bucket #	Bucket Type	Model #	# of Teeth	Weight	Order Code
	HD Replaceable Tooth	TB-8HDR	8	156 lbs.	303-072-000

\* May be ordered to fit over bolt-on cutting edge. A detailed diagram is required in order to ensure correct fitment.

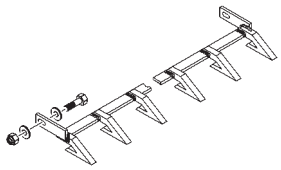

#### Standard Tooth

- Low-cost bar for light to moderate use

### New Holland

Bucket #	Bucket Type			Bucket Inside Dim.	
715712056	48" Material Bucket for 10LA			48"	
715712046	48" Material Bucket for 12LA			48"	
Bucket #	Bucket Type	Model #	# of Teeth	Weight	Order Code
	Standard Tooth	TBC-6S		47 lbs.	303-064-000
	Replaceable Tooth	TBC-6SR		54 lbs.	303-065-000

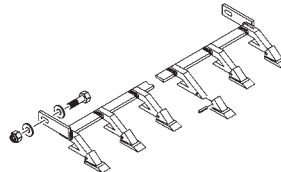

#### Replaceable Tooth

- For commercial or high use applications
- 2A points are pinned in place

Bucket #	Bucket Type			Bucket Inside Dim.	
7157135046	54" Material Bucket for 12LA			54"	
Bucket #	Bucket Type	Model #	# of Teeth	Weight	Order Code
	Standard Tooth	TBC-7Q	7	47 lbs.	303-055-000
	Replaceable Tooth	TBC-7QR	7	54 lbs.	303-056-000

Bucket #	Bucket Type			Bucket Inside Dim.	
715719036	60" Material Bucket for 14LA/15LA-Pin-On			60"	
715729036	60" Material Bucket for 14LA/15LA-Quick Attach			60"	
Bucket #	Bucket Type	Model #	# of Teeth	Weight	Order Code
	Standard Tooth	TBC-7B	7	47 lbs.	303-022-000
	Replaceable Tooth	TBC-7BR	7	54 lbs.	303-023-000

Tooth bar also fits: 715714001, 716424001



Bucket #	Bucket Type			Bucket Inside Dim.	
716425056	68" HD Material Bucket for 14LA/15LA-Quick-Attach			67-5/8"	
Bucket #	Bucket Type	Model #	# of Teeth	Weight	Order Code
	Standard Tooth	TBC-8D	8	53 lbs.	303-038-000
	Replaceable Tooth	TBC-8DR	8	61 lbs.	303-039-000

Tooth bar also fits: 715715001, 716425001

Bucket #	Bucket Type			Bucket Inside Dim.	
715717016	72" Material Bucket - Pin-On			72"	
715720016	72" HD Material Bucket - Pin-On			72"	
715730016	72" HD Material Bucket - Quick Attach			72"	
Bucket #	Bucket Type	Model #	# of Teeth	Weight	Order Code
	Standard Tooth	TBC-8N	8	53 lbs.	303-044-000
	Replaceable Tooth	TBC-8NR	8	61 lbs.	303-045-000

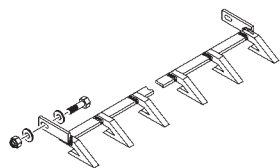

## TOOTH BARS (continued)

- Sized perfectly for compact tractors
- Standard or replacement teeth are available
- Available for buckets with 3/8" or 1/2" cutting edge
- Mounting hardware and instructions included
- Inexpensive ground shipment available

### John Deere

#### Standard Tooth

- Low-cost bar for light to moderate use

Bucket #	Bucket Type	Bucket Inside Dim.			
BW15041	48" Material Bucket for 45	47-3/4"			
Tooth Bar Type		Model #	# of Teeth	Weight	Order Code
Standard Tooth		TBC-6S	6	39 lbs.	303-064-000
Replaceable Tooth		TBC-6SR	6	45 lbs.	303-065-000

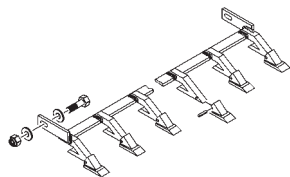

#### Replaceable Tooth

- For commercial or high use applications
- 2A points are pinned in place

Bucket #	Bucket Type	Bucket Inside Dim.			
BW14144	49" Material Bucket for 200X, 200CX, 210, 410, 419	48-13/16"			
Tooth Bar Type		Model #	# of Teeth	Weight	Order Code
Standard Tooth		TBC-6L	6	39 lbs.	303-016-000
Replaceable Tooth		TBC-6LR	6	45 lbs.	303-017-000

Bucket #	Bucket Type	Bucket Inside Dim.			
BW14145	53" Material Bucket for 200X, 200CX, 210, 300, 410	52-13/16"			
Tooth Bar Type		Model #	# of Teeth	Weight	Order Code
Standard Tooth		TBC-7M	7	47 lbs.	303-030-000
Replaceable Tooth		TBC-7MR	7	54 lbs.	303-031-000

Bucket #	Bucket Type	Bucket Inside Dim.			
BM17703	60" Material Bucket for 70, 70A	59-3/4"			
Tooth Bar Type		Model #	# of Teeth	Weight	Order Code
Standard Tooth		TBC-7F	7	45 lbs.	303-026-000
Replaceable Tooth		TBC-7FR	7	54 lbs.	303-027-000



Bucket #	Bucket Type	Bucket Inside Dim.			
BW14146	61" Material Bucket for 300, 300X, 300CX, 400X, 400CX, 419, 420, 430, 460	60-13/16"			
Tooth Bar Type		Model #	# of Teeth	Weight	Order Code
Standard Tooth		TBC-7G	7	47 lbs.	303-028-000
Replaceable Tooth		TBC-7GR	7	54 lbs.	303-029-000

Bucket #	Bucket Type	Bucket Inside Dim.			
BW14147	73" Material Bucket for 300, 300X, 300CX, 400X, 400CX, 419, 420, 430, 460	72-13/16"			
BW14658	73" High Volume Bucket for 300, 300X, 300CX, 400X, 400CX, 419, 420, 430, 460	72-13/16"			
Tooth Bar Type		Model #	# of Teeth	Weight	Order Code
Standard Tooth		TBC-8H	8	53 lbs.	303-040-000
Replaceable Tooth		TBC-8HR	8	61 lbs.	303-041-000

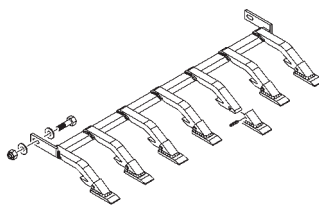

- Heavy Duty specs for Skid Steer & larger Tractor Loaders
- Series 23 teeth pinned in place
- May be ordered to fit over a bolt on cutting edge

Bucket #	Bucket Type	Bucket Inside Dim.	Edge Thickness		
BW14656	61" HD Bucket for 300, 300X, 300CX, 400X, 400CX, 419, 420, 430, 460	60-13/16"	3/4"		
BW14764	61" HD Bucket w/holes for 300, 300X, 300CX, 400X, 400CX, 419, 420, 430, 460	60-13/16"	3/4"		
BW14257	61" Materials Bucket for 512, 521, 522, 541, 542	60-13/16"	3/4"		
Tooth Bar Type		Model #	# of Teeth	Weight	Order Code
HD Replaceable Tooth		TB-6HDR	6	104 lbs.	303-073-000

Bucket #	Bucket Type	Bucket Inside Dim.	Edge Thickness		
BW14657	73" HD Bucket for 300, 300X, 300CX, 400X, 400CX, 430, 460	72-13/16"	3/4"		
BW14765	73" HD Bucket w/holes for 300, 300X, 300CX, 400X, 400CX, 430, 460	72-13/16"	3/4"		
BW14249	73" Material Bucket for 510, 512, 521, 522, 541, 542	72-13/16"	3/4"		
BW15019	73" HD Bucket for 512, 521, 522, 541, 542	72-13/16"	3/4"		
Tooth Bar Type		Model #	# of Teeth	Weight	Order Code
HD Replaceable Tooth		TB-7HDR	7	130 lbs.	303-074-000

\* May be ordered to fit over bolt-on cutting edge. A detailed diagram is required in order to ensure correct fitment.

## Tooth Bars for Compact Tractors

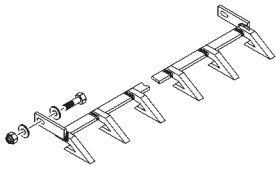

### TOOTH BARS (continued)

- Sized perfectly for compact tractors
- Mounting hardware and instructions included
- Standard or replacement teeth are available
- Inexpensive ground shipment available
- Available for buckets with 3/8" or 1/2" cutting edge

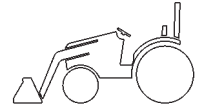

#### Standard Tooth

- Low-cost bar for light to moderate use

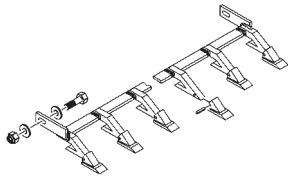

### Custom-Built

Number of Teeth	Model #	Fits Buckets	Order Code
6 Standard Teeth	TBC-6	41" - 50" I.D.	303-011-000
6 Replaceable Teeth	TBC-6R	41" - 50" I.D.	303-018-000
7 Standard Teeth	TBC-7	50" - 62" I.D.	303-019-000
7 Replaceable Teeth	TBC-7R	50" - 62" I.D.	303-034-000
8 Standard Teeth	TBC-8	62" - 72" I.D.	303-035-000
8 Replaceable Teeth	TBC-8R	62" - 72" I.D.	303-048-000

#### Replaceable Tooth

- For commercial or high use applications
- 2A points are pinned in place

2A-Style Replacement Tooth

001-001-023

**Note:** Please furnish bucket's inside dimension and cutting edge thickness when ordering tooth bars.

### Heavy-Duty TOOTH BAR - Replaceable Tooth

- Custom-built for buckets up to 96" in width
- Industrial-grade steel shanks with Series 23 tooth points pinned onto shanks
- Shanks are welded to cutting edge with slotted end tabs

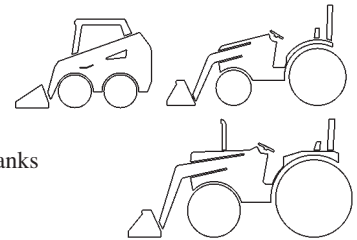

Number of Teeth	Model #	Fits Buckets	Cutting Edge	Order Code
6 Replaceable Teeth	TB-6HDR	50" - 62" I.D.	1/2" x 4"	303-067-000
7 Replaceable Teeth	TB-7HDR	62" - 72" I.D.	1/2" x 4"	303-068-000
8 Replaceable Teeth	TB-8HDR	72" - 84" I.D.	1/2" x 4"	303-069-000
9 Replaceable Teeth	TB-9HDR	84" - 96" I.D.	1/2" x 4"	303-070-000
23-Style Replacement Tooth				001-001-022
Series 23 Flex Pin				001-001-013

**Note:** Please furnish bucket's inside dimension and cutting edge thickness when ordering tooth bars.

\* May be ordered to fit over bolt-on cutting edge. A detailed diagram is required in order to ensure correct fitment.

- Heavy Duty specs for Skid Steer & larger Tractor Loaders
- Series 23 teeth pinned in place
- May be ordered to fit over a bolt on cutting edge

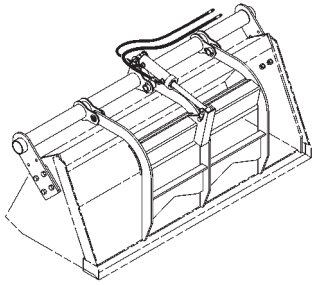

- Installation Available
- Fits 48" to 73" buckets

## GK-4866 GRAPPLE KIT for COMPACT TRACTOR LOADERS

- Kit fits compact tractor buckets 48" to 73" wide
- Single, three-tine grapple holds loose materials in bucket
- One, 1-3/4" dia. bore x 6" stroke hydraulic cylinder
- A third function hydraulic control valve is necessary to operate hydraulic cylinder
- Weld and trim tube to length

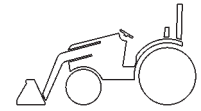

Type	No. Tines	Approx. Weight	Order Code
GK-4866 Grapple Kit for 48" - 73" Buckets	3	137 lbs.	300-039-000

\* Installation available for ATI Corporation buckets. Call for details.

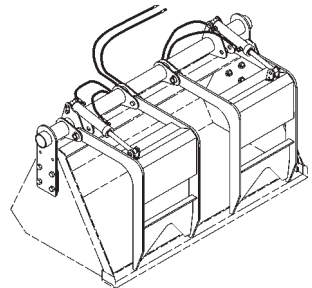

- Fits 60" to 84" Buckets
- Light duty grapple kit
- Bolt-on design for easy removal

## GK-6078 GRAPPLE KIT for UTILITY TRACTOR & SKID STEER LOADERS

- Kit fits buckets 60" to 84" wide
- Dual, two-tine grapple holds loose materials in bucket
- Two, 1-3/4" dia. bore x 6" stroke hydraulic cylinders
- A third function hydraulic control valve is necessary to operate hydraulic cylinders
- Weld and trim tube to length

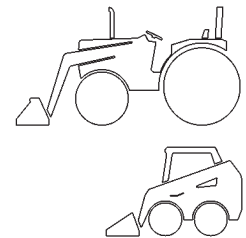

Type	No. Tines	Approx. Weight	Order Code
GK-6078 Grapple Kit for 60" - 84" Buckets	4	250 lbs.	300-040-000*

\*Note: Not intended for low profile dirt or 4-in-1 buckets

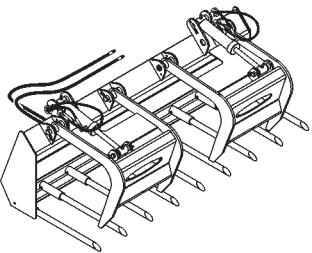

- Brush fork for compact loaders
- 32" Jaw Opening

## BF-Series BRUSH FORK for COMPACT TRACTOR LOADERS

- 1-1/4" Round tines easily penetrate brush
- Industrial-strength, 7 gauge and 1/4" steel construction
- Triangular torsion member reduces metal fatigue and adds strength
- 32" Jaw opening for large loads
- Fully shielded jaws protect cylinders
- Two, 2" dia. bore x 6" stroke hydraulic cylinders for clamping power
- Bucket comes fully plumbed with jumper hoses

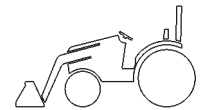

Note: Dealer must furnish hydraulic couplers. Tractor must be equipped with third function valve.

Type	No. Tines	Approx. Weight	Order Code
60" BF-60 Brush Fork	7	530 lbs.	300-013-000
66" BF-66 Brush Fork	9	565 lbs.	300-014-000
72" BF-72 Brush Fork	10	590 lbs.	300-015-000

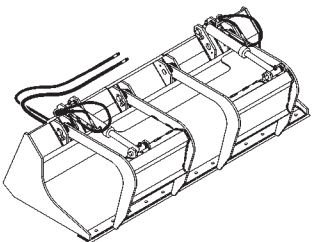

- Industrial grapple sizes for compact loaders
- 32" Jaw Opening

## GBC-Series GRAPPLE BUCKET for COMPACT TRACTOR LOADERS

- Industrial-strength, 7 gauge and 1/4" steel construction
- Triangular torsion member reduces metal fatigue and adds strength
- 32" Jaw opening for large loads
- Fully shielded jaws protect cylinders
- Two, 2" dia. bore x 6" stroke hydraulic cylinders for clamping power
- Pre-drilled cutting edge accepts bolt-on edge
- Bucket comes fully plumbed with jumper hoses

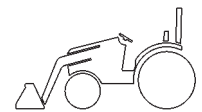

Note: Dealer must furnish hydraulic couplers. Tractor must be equipped with third function valve.

Type	Cutting Edge	No. Skids	Approx. Weight	Order Code
60" GBC-60 Grapple Bucket	1/2" x 4"	4	480 lbs.	300-005-000
66" GBC-66 Grapple Bucket	1/2" x 4"	4	505 lbs.	300-006-000
72" GBC-72 Grapple Bucket	1/2" x 4"	5	530 lbs.	300-007-000

### Bolt-on Cutting Edge for GBC-Series Grapple Buckets

1/2" x 6" x 60" Bolt-on edge & hardware	000-190-105
1/2" x 6" x 66" Bolt-on edge & hardware	000-190-106
1/2" x 6" x 72" Bolt-on edge & hardware	000-190-107

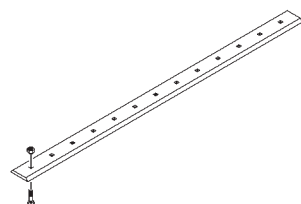

## Grapple Attachments

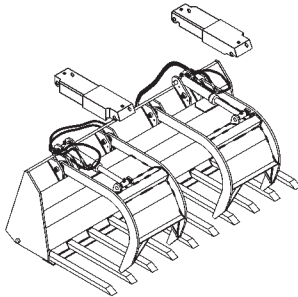

- Universal Quick Attach
- 43" Jaw Opening
- Cylinder shields available
- Open floor design

### CGF-Series CONSTRUCTION GRAPPLE FORK

- Industrial-strength, 1/4" and 3/8" steel plate construction
- Heat-treated 1-1/4" x 2" fork tines
- Triangular torsion member reduces metal fatigue and adds strength
- 43" Jaw opening for large loads
- Shielded grapple hooks protect cylinders, optional telescopic shields offer full protection
- Two, 2-1/4" dia. bore x 6" stroke hydraulic cylinders for clamping power
- Bucket comes fully plumbed to centrally-mounted junction block at rear of bucket

**Note:** Dealer must furnish hoses and hydraulic couplers from the loader to the junction block

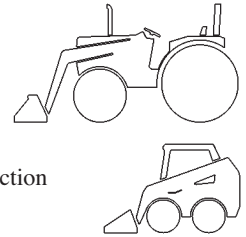

Type	No.	Approx.	Order Code
Universal Mount	Tines	Weight	
60" CGF-60 Grapple Fork - Custom Built	8	890 lbs.	300-020-000
60" CGF-60 Grapple Fork - Universal Mount	8	890 lbs.	300-024-000
66" CGF-66 Grapple Fork - Custom Built	9	920 lbs.	300-021-000
66" CGF-66 Grapple Fork - Universal Mount	9	920 lbs.	300-025-000
72" CGF-72 Grapple Fork - Custom Built	10	950 lbs.	300-022-000
72" CGF-72 Grapple Fork - Universal Mount	10	950 lbs.	300-026-000
78" CGF-78 Grapple Fork - Custom Built	11	980 lbs.	300-023-000
78" CGF-78 Grapple Fork - Universal Mount	11	980 lbs.	300-027-000
Replacement Tine		24 lbs.	001-001-005

**Option:** Telescopic Cylinder Shields - set of 2

300-123-000

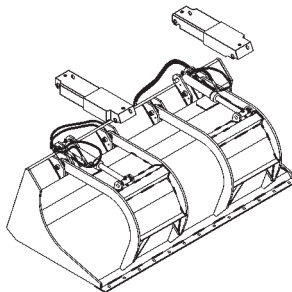

- Universal Quick Attach
- 43" Jaw Opening
- Cylinder shields available

### GB-Series INDUSTRIAL GRAPPLE BUCKET

- Industrial-strength, 1/4" and 3/8" steel plate construction
- Triangular torsion member reduces metal fatigue and adds strength
- 43" Jaw opening for large loads
- Shielded grapple hooks protect cylinders, optional telescopic shields offer full protection
- Two, 2-1/4" dia. bore x 6" stroke hydraulic cylinders for clamping power
- 3/4" x 6" cutting edge with holes is standard equipment
- Bucket comes fully plumbed to centrally-mounted junction block at rear of bucket

**Note:** Dealer must furnish hoses and hydraulic couplers from the loader to the junction block

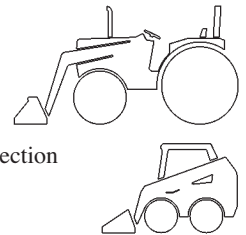

Type	No.	Approx.	Order Code
Universal Mount	Skids	Weight	
60" GB-60 Grapple Bucket - Custom Built	4	780 lbs.	300-001-000
60" GB-60 Grapple Bucket - Universal Mount	4	780 lbs.	300-008-000
66" GB-66 Grapple Bucket - Custom Built	4	805 lbs.	300-002-000
66" GB-66 Grapple Bucket - Universal Mount	4	805 lbs.	300-009-000
72" GB-72 Grapple Bucket - Custom Built	5	840 lbs.	300-003-000
72" GB-72 Grapple Bucket - Universal Mount	5	840 lbs.	300-010-000
78" GB-78 Grapple Bucket - Custom Built	5	875 lbs.	300-004-000
78" GB-78 Grapple Bucket - Universal Mount	5	875 lbs.	300-011-000

**Options:** Telescopic Cylinder Shields - set of 2

300-123-000

### **Bolt-on Cutting Edge Option for GB-Series Grapple Bucket**

5/8" x 6" x 60" Bolt-on edge & hardware	000-190-135
5/8" x 6" x 66" Bolt-on edge & hardware	000-190-136
5/8" x 6" x 72" Bolt-on edge & hardware	000-190-137
5/8" x 6" x 78" Bolt-on edge & hardware	000-190-138

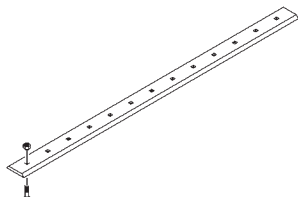

## MANURE FORKS

### Flat Tine

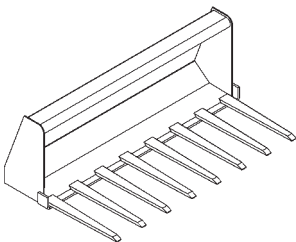

- Designed for maximum durability
- 5/8" thick spring steel tines taper from 1-1/2" to 3-1/4" at rear
- Tines are bolted into 10" deep bucket back



- Custom-Built or Universal Quick Attach
- Durable spring steel tines

Type	Approx. Weight	No. Tines	Order Code
48" Universal Mount Flat Tine Fork	335 lbs.	6	307-010-000
48" Custom Built Flat Tine Fork		6	307-000-000
56" Universal Mount Flat Tine Fork	365 lbs.	7	307-011-000
56" Custom Built Flat Tine Fork		7	307-001-000
64" Universal Mount Flat Tine Fork	400 lbs.	8	307-012-000
64" Custom Built Flat Tine Fork		8	307-002-000
72" Universal Mount Flat Tine Fork	435 lbs.	9	307-013-000
72" Custom Built Flat Tine Fork		9	307-003-000
78" Universal Mount Flat Tine Fork	470 lbs.	10	307-014-000
78" Custom Built Flat Tine Fork		10	307-004-000
33" Replacement Fork Tine w/5/8" Hole			307-019-000

### Round Tine

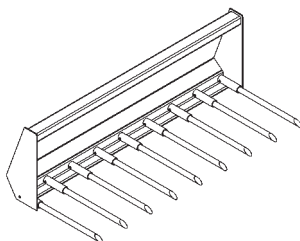

- Economy-priced manure fork
- 1-1/4" round tines are constructed of an axle steel to prevent bending
- Tines are mounted in sockets with cotter pin



- Custom-Built or Universal Quick Attach
- Low cost round tines

Type	Approx. Weight	No. Tines	Order Code
40" Custom Built Round Tine Fork	205 lbs.	6	307-005-000
48" Universal Mount Round Tine Fork	245 lbs.	7	307-015-000
48" Custom Built Round Tine Fork		7	307-006-000
56" Universal Mount Round Tine Fork	280 lbs.	8	307-016-000
56" Custom Built Round Tine Fork		8	307-007-000
64" Universal Mount Round Tine Fork	315 lbs.	9	307-017-000
64" Custom Built Round Tine Fork		9	307-008-000
72" Universal Mount Round Tine Fork	385 lbs.	10	307-018-000
72" Custom Built Round Tine Fork		10	307-009-000
25" Replacement Fork Tine			307-020-000
Replacement Tine Socket			307-021-000

## WELD-ON ATTACHMENT PLATES

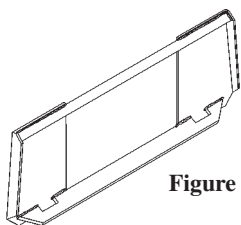

Figure A

- Converts old attachments to new loaders
- Plate steel backing for solid mounting
- Over 200 different types available, see fit list on page 32, 33 please call for pricing
- Can be quickly welded onto any attachment
- Inexpensive ground shipment

- Converts attachments to Universal Mount Quick Attach
- Weld-on design
- Directions Included

Type	Approx. Weight	Order Code
Universal Mount - Figure A	51 lbs.	301-001-000

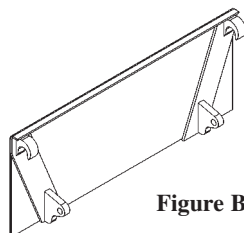
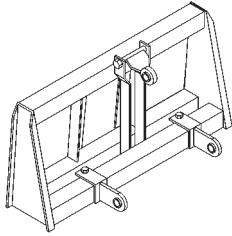

Figure B

Type	Approx. Weight	Order Code
ALO Quicke, European style, Global Carrier - Figure B	81 lbs.	301-045-000
Case 1838, 1840, 1845C	58 lbs.	301-002-000
John Deere 210, 200X, 300X, 400X, 410, 419, 420, 430, 440QA, 460	67 lbs.	301-015-000
John Deere 510, 512, 520, 521, 522, 540, 541, 542	76 lbs.	301-005-000
John Deere 620, 640, 720, 721, 725, 726, 740, 741, 746	161 lbs.	301-006-000 <sup>1</sup>
<sup>1</sup> Requires John Deere latch kit #BW15085 or ATI Corporation P/N 001-001-068.		
Kubota R-series (Gannon QA)	125 lbs.	301-007-000

Type	Approx. Weight	Order Code
New Holland L555/785, Deere 675/675B	70 lbs.	301-009-000
New Holland L455, Deere 575	44 lbs.	301-010-000

**\*Custom-built attachment plates are available. Please call for a quote.**



- Universal Quick Attach
- Ball joints at all three points

### THREE-POINT HITCH ADAPTER

- Enables three point tools to be used on a loader
- Ball ends at all three points make hook-ups easy
- Heavy-duty construction
- Sliding links attach to Cat. 1 equipment
- Cat. 2 ball ends available



Type	Approx. Weight	Order Code
Universal Mount	195 lbs.	309-500-000
Three-Point Hitch Adapter Cat.1 - Custom Built*	195 lbs.	309-501-000

**SS-3PT**  
Optional Cat.: 2 Ball Ends  
2" Trailer Receiver

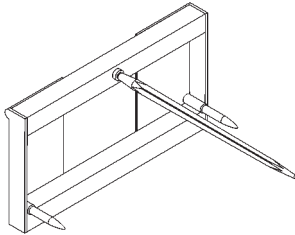

- Custom-Built or Universal Quick Attach
- 38" or 49" Fully Tapered Spear
- Spear Kits available on Page 31

### BALE SPEAR ATTACHMENT

- Constructed from rugged, square tubing for durability
- One, 1-3/4" thick carrying spear is made from drop-forged alloy steel, 38" or 49" long
- Tapered sleeve and nut anchor the carrying spear
- Two, stabilizer spears are bolted into the frame

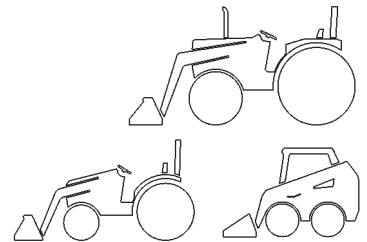

Type	Approx. Capacity	Approx. Weight	Order Code
Universal Mount			
Frame w/ 38" Bale Spear	2600 lbs.@ 31-1/2"	222 lbs.	309-007-000
Frame w/ 49" Bale Spear	2600 lbs.@ 31-1/2"	225 lbs.	309-000-000
Custom Built*			
Frame w/38" Bale Spear	2600 lbs.@31-1/2"	222 lbs.	309-008-000
Frame w/49" Bale Spear	2600 lbs.@31-1/2"	225 lbs.	309-001-000

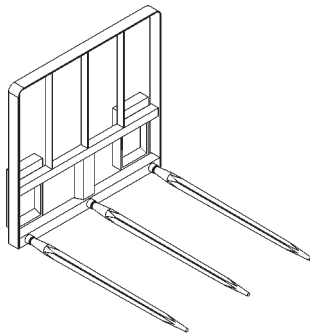

- Custom-Built or Universal Quick Attach
- Three Spears for Large Square Bales
- Spear Kits available on Page 31

### BIG BALE SPEAR ATTACHMENT

- Constructed from rugged, square tubing for durability
- Three, 1-3/4" thick carrying spears made from drop-forged alloy steel, 38" or 49" long
- Tapered sleeve and nut anchor the carrying spears

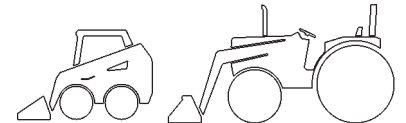

Type	Approx. Capacity	Approx. Weight	Order Code
Universal Mount			
Big Bale Spear Frame w/3-38" spears	2600 lbs.@ 31-1/2"	270 lbs.	309-005-000
Big Bale Spear Frame w/3-49" spears	2600 lbs.@ 31-1/2"	280 lbs.	309-003-000
Custom Built			
Big Bale Spear Frame w/3-38" spears	2600 lbs.@ 31-1/2"	270 lbs.	309-006-000
Big Bale Spear Frame w/3-49" spears	2600 lbs.@ 31-1/2"	280 lbs.	309-004-000

\* Note: The wide-frame version is required on loaders with a frame width over 46" o.d.

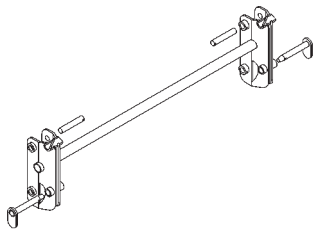

## ***PIN-TYPE QUICK ATTACH for COMPACT TRACTOR LOADERS***

- Simple, inexpensive quick attach for lower capacity loaders
- Hook into top bucket pins, manually insert tapered, lower pins
- Quickly change attachments or drop bucket for better maneuverability
- No modifications to original bucket are necessary
- Quick attach comes complete with pins
- Low cost shipping

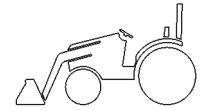

- Low cost Quick Attach
- Uses existing attachments

### **Fits Loader Model**

Kubota LA271, LA272, LA301 & LA302  
 Kubota LA351 & LA352  
 Kubota LA463 & LA513

New Holland 7106, 7108 & 7308  
 Case IH L130  
 New Holland 12LA  
 Case IH LX112  
 Bush Hog M146

### **Shipping**

#### **Weight    Order Code**

21 lbs.	100-050-000
32 lbs.	100-051-000
41 lbs.	100-063-000
40 lbs.	100-052-000
34 lbs.	100-058-000
33 lbs.	100-090-000

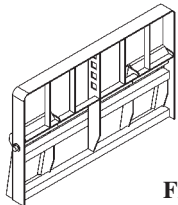

**Figure A**

## ***PALLET FORKS for COMPACT TRACTOR LOADERS***

- Designed specifically for compact tractor loaders with capacities less than 1450 lbs.
- Shaft-mounted 1-1/4" x 2-1/4" forged steel forks, 2000 lbs. capacity
- 32" or 42" forks are available
- Infinite fork adjustment to 46" wide
- Overall height is 30"
- Pin-type or quick attach mounts available

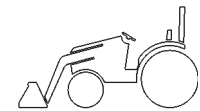

- Universal Mount Quick Attach
- 32" or 42" Forks

### **Frame Type**

#### **Figure A**

Universal mount Quick Attach

### **Approx.**

#### **Weight    Order Code**

132 lbs.	305-004-000
----------	-------------

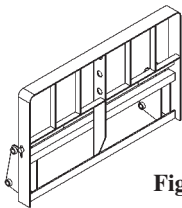

**Figure B**

### **Frame Type**

#### **Figure B**

John Deere 200CX, 210, 300, 300X, 300CX, 400X, 410, 419, 420 & 430  
 John Deere 70 & 70A  
 Kubota LA402, LA482  
 Kubota LA181, LA210 & LA211, LA203, LA240, LA243  
 Kubota LA272, LA302  
 Kubota LA351, LA352  
 Kubota TL420, TL421  
 New Holland 7106 & 7308, Case IH L130  
 New Holland 12LA, Case IH LX112  
 Custom-built frame

### **Approx.**

#### **Weight    Order Code**

128 lbs.	305-005-000
108 lbs.	305-006-000
106 lbs.	305-007-000
120 lbs.	305-008-000
104 lbs.	305-009-000
107 lbs.	305-010-000
106 lbs.	305-013-000
108 lbs.	305-011-000
108 lbs.	305-016-000
110 lbs.	305-012-000

- Designed for compact tractors
- Pin Type or Quick Attach Mounts available
- 32" or 42" Forks

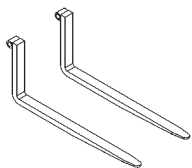

## ***PALLET FORKS for Figures A & B***

- European manufactured

### **Fork Type**

32" Forks, Pallet, Pair of Shaft-Mounted  
 42" Forks, Pallet, Pair of Shaft-Mounted

### **Weight**

#### **Pair    Order Code**

84 lbs.	000-205-015
92 lbs.	000-205-016

- 1-1/4" X 2-1/4" forged steel forks
- 32" or 42" lengths

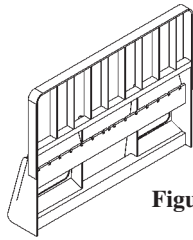
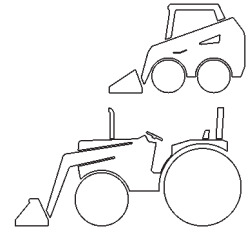

**Figure C**

- Universal Mount Quick Attach
- Forged Top Rail Carries Forks
- Integral Spill Guard

### ***PALLET FORKS***

- Heavy-duty frame withstands stresses of daily use
- High-capacity forks are adjustable from 4" to 44" wide, up to 64" wide on wide mounting frame
- Forks are standard taper, ITA Class II
- Overall height is 40"
- Wide frame version is required for some loaders see note below\*



**Frame Type**

**Figure C**

Frame, Universal Mount ITA Class II

**Approx.  
Weight**

**Order Code**

247 lbs. 305-001-000

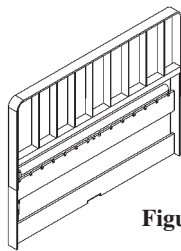

**Figure D**

- Pin Type or Quick Attach Mounts Available
- Two solid forged rails

**Frame Type**

**Figure D**

Mounting Frame HD - Pin-Type or Quick Attach Custom Built

**Approx.  
Weight**

**Order Code**

260 lbs. 305-002-000

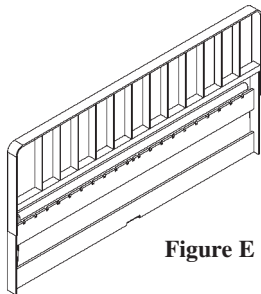

**Figure E**

- Pin Type or Quick Attach Mounts Available
- Two solid forged rails

**Frame Type**

**Figure E**

Wide Mounting Frame WF - Pin-Type or Quick Attach Custom Built\*

**Approx.  
Weight**

**Order Code**

340 lbs. 305-003-000\*

\* **Note:** The wide-frame version is required on loaders with a frame width over 46" o.d.

### ***PALLET FORKS for Figures C, D & E***

- European manufactured

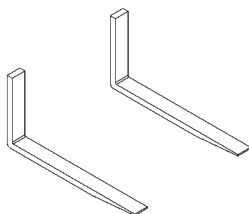

- 4" Wide ITA Class II fork
- 36", 42", 48" & 60" lengths

**Fork Type**

36"/3000lb.-ITA Class II Fork, Pair  
42"/4000lb.-ITA Class II Fork, Pair  
48"/4000lb.-ITA Class II Fork, Pair

42"/6800lb.-ITA Class II Fork, Pair  
48"/6800lb.-ITA Class II Fork, Pair  
60"/6800lb.-ITA Class II Fork, Pair

**Weight  
Pair**

156 lbs.  
174 lbs.  
188 lbs.

**Order Code**

000-205-017  
000-205-032  
000-205-033

200 lbs.  
226 lbs.  
260 lbs.

000-205-034  
000-205-035  
000-205-022

## WELD-ON BUCKET TEETH

### Series 2A Crimp-On Style

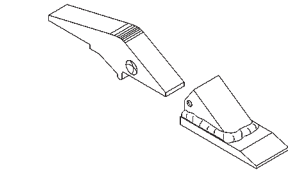

Type	Length	Width	Weight	Order Code
2A Fabricated Tooth	4.12"	1.75"	1.00 lbs.	001-001-023
2A Crimp-On Shank	6.87"	1.00"	1.89 lbs.	001-001-018

Installation of one Series 2A Crimp-On Shank and Tooth onto Bucket

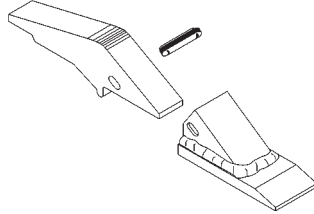

### Series 23 Pin-On Style

Type	Length	Width	Weight	Order Code
Series 23 Fabricated Tooth	5.12"	2.25"	2.08 lbs.	001-001-022
Series 23 Flex Pin	2.00"	.688"	.10 lbs.	001-001-013
Series 23 Pin-On Shank	8.00"	1.50"	4.09 lbs.	001-001-014

Installation of one Series 23 Pin-On Shank and Tooth onto Bucket

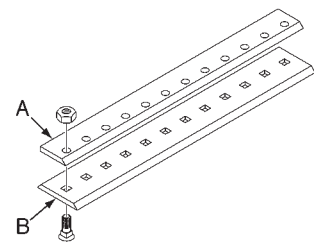

## BOLT-ON REVERSIBLE CUTTING EDGE

- Greatly reduces the time required to replace the bucket cutting edge.
- Double-bevel flat edge can be reversed for twice the wear
- High-carbon steel incorporates the long-wearing characteristics of weld-on cutting edge
- Deep countersunk holes keep bolt heads from wearing

**Please Note:** The bucket must be equipped with a base, weld-on cutting edge with 11/16" holes on 6" centers. The bolt-on edge is fastened to the base with 5/8" plow bolts.



### Weld-on Base w/holes A

Size	Type	Weight	Order Code
1/2" x 4" x 61-3/8"	Weld-on base w/holes	31 lbs.	000-190-042
1/2" x 4" x 67-3/8"	Weld-on base w/holes	34 lbs.	000-190-043
1/2" x 4" x 73-3/8"	Weld-on base w/holes	37 lbs.	000-190-044
3/4" x 6" x 61-3/8"	Weld-on base w/holes	48 lbs.	000-190-061
3/4" x 6" x 67-3/8"	Weld-on base w/holes	53 lbs.	000-190-062
3/4" x 6" x 73-3/8"	Weld-on base w/holes	58 lbs.	000-190-064
3/4" x 6" x 79-7/8"	Weld-on base w/holes	76 lbs.	000-190-065
3/4" x 6" x 85-7/8"	Weld-on base w/holes	84 lbs.	000-190-066
3/4" x 6" x 91-7/8"	Weld-on base w/holes	90 lbs.	000-190-067
3/4" x 6" x 97-7/8"	Weld-on base w/holes	111 lbs.	000-190-068
3/4" x 6" x 103-7/8"	Weld-on base w/holes	119 lbs.	000-190-069

### Bolt-on Edge B

Size	Type	Weight	Order Code
1/2" x 6" x 61-3/8"	Bolt-on edge w/holes	48 lbs.	000-190-073
1/2" x 6" x 67-3/8"	Bolt-on edge w/holes	53 lbs.	000-190-074
1/2" x 6" x 73-3/8"	Bolt-on edge w/holes	58 lbs.	000-190-076
5/8" x 6" x 61-7/8"	Bolt-on edge w/holes	59 lbs.	000-190-083
5/8" x 6" x 67-7/8"	Bolt-on edge w/holes	65 lbs.	000-190-084
5/8" x 6" x 73-7/8"	Bolt-on edge w/holes	71 lbs.	000-190-085
5/8" x 6" x 79-7/8"	Bolt-on edge w/holes	76 lbs.	000-190-086
5/8" x 6" x 85-7/8"	Bolt-on edge w/holes	82 lbs.	000-190-087
5/8" x 6" x 91-7/8"	Bolt-on edge w/holes	88 lbs.	000-190-088
5/8" x 6" x 97-7/8"	Bolt-on edge w/holes	93 lbs.	000-190-089
5/8" x 6" x 103-7/8"	Bolt-on edge w/holes	99 lbs.	000-190-090
3/4" x 8" x 73-7/8"	Bolt-on edge w/holes	105 lbs.	000-190-156
3/4" x 8" x 85-7/8"	Bolt-on edge w/holes	123 lbs.	000-190-157
3/4" x 8" x 97-7/8"	Bolt-on edge w/holes	140 lbs.	000-190-124
5/8" x 1-1/2"	Grade 8 Plow Bolt with Nut	-	000-150-255
5/8" x 1-3/4"	Grade 8 Plow Bolt with Nut	-	000-150-260
5/8" x 2"	Grade 8 Plow Bolt with Nut	-	000-150-261

## Replacement Bale Spears, Teeth and Edges

### REPLACEMENT CUTTING EDGES and END PIECES

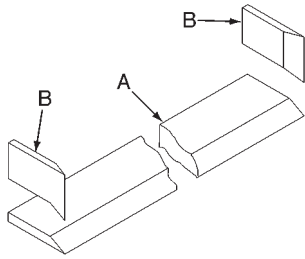

#### Pre-cut Weld-on Cutting Edge A

- High carbon, single bevel steel cutting edge
- Pre-cut lengths in many sizes

Size	Type	Weight	Order Code
1/2" x 3" x 61-3/8"	Weld-on Cutting Edge	23 lbs.	000-190-007
1/2" x 3" x 67-3/8"	Weld-on Cutting Edge	25 lbs.	000-190-008
1/2" x 3" x 73-3/8"	Weld-on Cutting Edge	28 lbs.	000-190-009
1/2" x 4" x 61-3/8"	Weld-on Cutting Edge	31 lbs.	000-190-013
1/2" x 4" x 67-3/8"	Weld-on Cutting Edge	34 lbs.	000-190-014
1/2" x 4" x 73-3/8"	Weld-on Cutting Edge	37 lbs.	000-190-015
3/4" x 4" x 61-7/8"	Weld-on Cutting Edge	44 lbs.	000-190-023
3/4" x 4" x 67-7/8"	Weld-on Cutting Edge	49 lbs.	000-190-024
3/4" x 4" x 73-7/8"	Weld-on Cutting Edge	53 lbs.	000-190-025
3/4" x 4" x 79-7/8"	Weld-on Cutting Edge	57 lbs.	000-190-026
3/4" x 4" x 85-7/8"	Weld-on Cutting Edge	61 lbs.	000-190-027
3/4" x 6" x 61-7/8"	Weld-on Cutting Edge	70 lbs.	000-190-031
3/4" x 6" x 67-7/8"	Weld-on Cutting Edge	77 lbs.	000-190-032
3/4" x 6" x 73-7/8"	Weld-on Cutting Edge	84 lbs.	000-190-033
3/4" x 6" x 85-7/8"	Weld-on Cutting Edge	98 lbs.	000-190-036
3/4" x 6" x 97-7/8"	Weld-on Cutting Edge	112 lbs.	000-190-038
3/4" x 6" x 103-7/8"	Weld-on Cutting Edge	119 lbs.	000-190-039

#### Weld-on End Pieces B

- End pieces are cut in the profile of the base edge for a neat fit
- Weld-on end pieces are better than a single, formed piece for several reasons:
  1. **Strength:** Heating and bending the ends weakens the edge at the most critical point – the corners. Welding the end pieces create a strong, straight corner.
  2. **Precise fit:** You control the spacing of the end pieces to ensure a proper fit.
  3. **Easy Installation:** You can quickly install the pieces in the corners. This saves time over trying to make a large bucket fit a small edge or by filling in gaps with weld.
  4. **Cost:** End pieces take less time to manufacture, which saves you money.

Size	Order Code
1/2" x 3" End Piece Set	000-190-094
1/2" x 4" End Piece Set	000-190-095
3/4" x 4" End Piece Set	000-190-097
3/4" x 6" End Piece Set	000-190-098

### BALE SPEAR

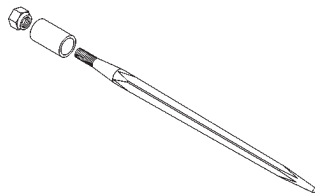

Type	Tine Capacity	Approx. Weight	Order Code
38" Spear, Socket, & Tapered Nut	2600 lbs. @ 31-1/2"	19 lbs.	001-001-027
49" Spear, Socket, & Tapered Nut	2600 lbs. @ 31-1/2"	28 lbs.	001-001-028



**Compact Tractor**

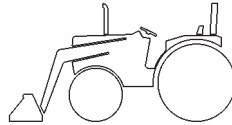

**Utility Tractor**



**Skid Steer**

## Ordering Tips:

- Know Your Loader Model. On what model loader will the attachment be mounted?
- Is the attachment mounting Quick Attach or a Pin-type mount?
- Know Your Customers' Needs.
  1. How often is the loader used?
  2. What type of material will the loader be carrying?
  3. What is critical to the customer? Capacity, versatility, or visibility of the edge while digging?

The following loaders have been fitted and attachments may be ordered to mount to these loaders. Please be aware that prices may vary depending on the design differences of each loader. The loader fit list is not all-inclusive, please call if you do not see your loader on the list.

### AGCO/Allis Chalmers/Deutz Allis:

Quick Attach - SL44A, SL46A, SL48A  
 Pin Type - 400, 450, 456, 460, 500, 680, SL44, SL46, SL48

### Bobcat:

Quick Attach - 300-400 series, 463, 500-800 series, 920, 943<sup>1</sup>, 953<sup>1</sup>, 963, 1600, 2000, 2410, MT50, MT52, MT55, T190, T200  
 Pin Type - 600, 610M

### Branson:

Quick Attach - BL10, BL20

### Bush Hog:

Pin Type - 2840, 2845, 3450, 2425, 2440, 2445

### Case/Case IH/International:

Quick Attach - 410, 420, 430, 435, 440, 445, 450, 465, 1530, 1537, 1737, 1740, 1816, 1818, 1825, 1830, 1835, 1835B, 1835C, 1838, 1840, 1845, 1845B, 1845C, 510<sup>1</sup>, 520<sup>1</sup>, L300<sup>1</sup>, L400, L450, L500, L550, L600, L650, L700, L750, L850, 710<sup>1</sup>, 720<sup>1</sup>, 890<sup>1</sup>, 2250, 2255, 2350, LX114, LX116, LX118, LX132, LX152, LX156, LX162, LX172, LX192, LX232, LX252, LX720, LX730, LX740, LX750, LX760, LX770, LX780, 2450, 3200, 3300, 4120, 4130, 4140, 40XT, 60XT, 70XT, 75XT, 85XT, 90XT, 95XT  
 Pin Type - 54L, 56L, 60, 74L, 1818, 1830, 1835, 1835B, 1835C, 5Q, 7Q, 10Q, L106, L108, 510<sup>1</sup>, 520<sup>1</sup>, 1850, 2000, 2050, 2200, 2250, 2255, 2350, 2450, 3200, 3300, KMW835, LX110, LX112, LX114, LX116, LX118

### Caterpillar:

Quick Attach - 216, 226, 228, 232, 236, 242, 246, 247, 248, 252, 257, 262, 267, 277, 287

### Challenger:

Quick Attach - ML30B, ML40B, ML72, ML75, ML77, ML92, ML94, ML96, ML97, ML98, ML99  
 Pin Type - ML20, ML30, ML40

### Cub Cadet:

Pin Type - 416, 417, 476, 833

### Daewoo:

Quick Attach - DSL601, 1760XL

### Dunham Lehr/Farmhand:

Pin Type - 2, 22, 520

### Ford/Ford New Holland/New Holland:

Quick Attach - CL-30, CL-340, CL-40, CL-45, CL-55<sup>1</sup>, CL-65<sup>1</sup>, L35, L-225, L-250 series, L-325, L-450 series, L-460 series, L-550 series, L-560 series, L-660 series, L-770 series, L-780 series, L-800 series, L-900 series, 14LA, 15LA, 16LA, 17LA, 18LA, 32LC, 32LA, 33LA, 46LB, 52LC, 52LA, 56LB, LB600, LB620, LS120, LS125, LS140, LS150, LS160, LS170, LS180, LS190, 7210<sup>1</sup>, 7309<sup>1</sup>, 7310<sup>1</sup>, 7312<sup>1</sup>, 7314<sup>1</sup>, 7410<sup>1</sup>, 7410HD<sup>1</sup>, 7411<sup>1</sup>, 7412<sup>1</sup>, 7413<sup>1</sup>, 7414<sup>1</sup>, 7614<sup>1</sup>, 9030<sup>1</sup>, 256<sup>1</sup>, 276<sup>1</sup>, 240TL, 250TL, 260TL, 270TL, 620TL, 810TL, 820TL, 830TL, 840TL, 850TL, 860TL, 870TL  
 Pin Type - 10LA, 12LA, 14LA, 15LA, 16LA, 17LA, 18LA, 32LA, 33LA, 340B, 345C, 345D, 445<sup>3</sup>, 445A<sup>3</sup>, 445C, 445D, 455C, 545<sup>3</sup>, 545A<sup>3</sup>, 545C, 545D, 555, 555A, 555B, 555C, 555D, 575D, 655, 655A, 655C, 655D, 675D, 555E, 575E, 655E, 675E, 703, 720, 730, 735, 740, 744, 745, 768, 768A, 768B, 770, 770A, 770B, 772, 776A, 776B<sup>1</sup>, 776F<sup>1</sup>, 777B<sup>1</sup>, 777D<sup>1</sup>, 777F<sup>1</sup>, 2109<sup>1</sup>, 7106, 7108, 7109<sup>1</sup>, 7209<sup>1</sup>, 7308, 7309<sup>1</sup>, 7210<sup>1</sup>, 7310<sup>1</sup>, 7410<sup>1</sup>, 230TL, 240TL, 250TL, 260TL

### Gehl:

Quick Attach - 2000 series, 3310, 3410, 3510, 3610, 3615, 3635, 3725, 3825, 3935, 4400, 4500, 4510, 4515, 4525, 4600, 4610, 4615, 4625, 4635, 4640, 4835, 4840, 5620, 5625, 5635, 5640, 6620, 6625, 6635, 6640, 7600, 7610, 7800, 7810, CTL60, CTL70, CTL80



New Holland, PA 17557

Phone (717) 354-8721 • FAX (717) 354-2162

1-800-342-0905 • www.preseeder.com

# 2007 Product List

## Loader Fit List

### Great Bend:

Quick Attach - 330<sup>1</sup>, 360<sup>1</sup>, 440<sup>1</sup>, 570<sup>1</sup>, 660<sup>1</sup>, 760<sup>1</sup>, 770<sup>1</sup>, 860<sup>1</sup>, 870<sup>1</sup>  
Pin Type - 240, 260, 280

### JCB:

Quick Attach - 150, 165, 185, 1105, 208S, 160, 170, 190, 1110

### John Deere:

Quick Attach - 24, 24A, 60, 70, 90, 110, 125, 170, 200X/200CX, 210, 240, 245, 250, 260, 260(SSL), 265, 270, 280, 280<sup>1</sup>, 300X/300CX, 375, 400X/400CX, 410, 420, 430, 440, 460, 510, 512, 520, 521, 522, 540, 541, 542, 563<sup>3</sup>, 570, 575, 620<sup>1,2</sup>, 640<sup>1,2</sup>, 673<sup>3</sup>, 675, 675B, 720<sup>1,2,4</sup>, 721<sup>1,2</sup>, 725<sup>1,2</sup>, 726<sup>1,2</sup>, 740<sup>1,2,4</sup>, 741<sup>1,2</sup>, 746<sup>1,2</sup>, 840<sup>1</sup>, 843<sup>1</sup>, 3375, 4475, 6675, 7775, 8875,  
Pin Type - 24, 24A, 170, 35, 36A, 37, 37A, 46A, 47, 48, 52, 60, 67, 70A, 75, 80, 100, 143, 145, 146, 148, 157, 158, 175, 440

### Kioti:

Pin Type - KL120, KL130, KL1230, KL1231, KL1450, KL1470

### Kubota:

Quick Attach - LA513, LA514, LA723, LA724, LA853, LA854, LA1001, LA1002, LA1153, LA1162, LA1251, LA1301, LA1301S, LA1353, LA1403, LA1601, LA1601S, M1410, TL500, TL1000, TL1150, R400, R410, R420, R510, R520  
Pin Type - 1200, B1640, B1630C, BF300, BF350, BF400, BF450, BF500, BF550, BF800, BF900, BF1100, LA181, LA203, LA211, LA240, LA243, LA271, LA272, LA300, LA301, LA302, LA350, LA351, LA400, LB400, LA401, LA402, LA403, LA450, LA452, LA463, LA480, LA481, LA482, LA500, LA513, LA650, LA680, LA681, LA682, LA703, LA723, LA724, LA852, LA853, LA854, LA950, LA950A, LA1100, LA1150, LB402, LB552, LB702, TL720, LA1001, LA1002, M1000, TL420, TL421, TL1150

### Massey Ferguson:

Quick Attach - 1525, 1530  
Pin Type - 711, 1200, 235, 236, 1246, 232, 832, 932, 1036, 1038, 1040, 1048, 1050, 1056, 1464, 1466, 1520

### Mahindra:

Pin Type - ML108H, ML112

### Mustang/Owatonna:

Quick Attach - 310, 312, 320, 332, 330, 342, 345, 441, 442, 445, 545, 552, 770, 920, 921, 930, 930A, 940, 960, 1200, 1700, 2040, 2050, 2060, 2070  
Pin Type - 441, 442, 1000, 1200, 1700

### Quicke/ALO:

Quick Attach - 310, Q330, Q430, Q450, Q610, Q620, Q630, Q640, Q650, Q660, Q670, Q690

### Schwartz:

Pin Type - 64Q, 84Q, 1200, 1300, 1350

### Thomas:

Quick Attach - 95, 105, 115, T103, T132, T133, T135, T153, T173<sup>1</sup>, 175, T183HD<sup>1</sup>, T203<sup>1</sup>, T232<sup>1</sup>, T233<sup>1</sup>, T233HD<sup>1</sup>, T243HD, T244HD, T245

### Trak International/Scat Trak:

Quick Attach - 1300, 1300C, 1300D, 1500C, 1500D, 1700, 1700C, 1750D, 2000D, 2300D

### Woods/Dual:

Quick Attach - 1012, 1016, 1020, 1027, 110<sup>1</sup>, 115<sup>1</sup>, 195<sup>1</sup>, 200<sup>1</sup>, 205<sup>1</sup>, 210<sup>1</sup>, 215<sup>1</sup>, 255<sup>1</sup>, 260<sup>1</sup>, 315<sup>1</sup>, 355<sup>1</sup>, 360<sup>1</sup>  
Pin Type - 165, 195, 1006, 1009, 1012, 1016

<sup>1</sup> Width of the loader frame requires the wide-frame version of some attachments. Call ATI Corporation for a price quotation.

<sup>2</sup> Requires John Deere latch kit #BW15085 or ATI Corporation P/N 001-001-068. The loader also requires the wide-frame version of some attachments.

<sup>3</sup> Dealer must specify loader type: 4 bar or direct.

<sup>4</sup> Dealer must specify loader type: standard or mechanical self-leveling.

<sup>5</sup> Dealer must specify quick attach type: Global carrier, Deere 600-style, or skid steer style.