

Instruction Manual

Model GA-52Cx Magnetic Locator

Manufactured By
Schonstedt Instrument Company
100 Edmond Road
Kearneysville, WV 25430
(304) 725-1050
Fax (304) 725-1095

Made in USA

Preface

The Model GA-52Cx Magnetic Locator is a product of over forty-five years of experience in producing the world's finest flux-gate magnetometers and magnetic detectors for aerospace, military and civilian applications. The GA-52Cx incorporates the knowledge obtained from manufacturing under the most rigid quality control standards. The heart of the GA-52Cx is its patented Schonstedt HeliFlux[®] magnetic field sensors. These sensors, acknowledged to be the world's finest, make possible the unequaled performance of our locators.

June 2003

Table of Contents

Operation	Page
Introduction	3
Turn-On, Volume and Sensitivity Settings	3
Search Procedure	4
Application Notes	
Basic Signal Patterns	5
Strongly Magnetized Markers	6
Locating Manholes, Septic Tanks and Well Casings	7
Locating Objects under Snow or Water and Tracing Barbed Wire	8
Searching Areas Along a Chain Link Fence	9
Locating Valve Boxes	10
Locating Cast-Iron Pipes	10
Locating Steel Drums	11
Additional Applications	11
Other Notes	11
Maintenance	
Replacement of Batteries	12
Troubleshooting Guide	13
Service Information	13
Specifications	13
Warranty and Shipping Information	14

Important Notice

Schonstedt believes the statements contained herein to be accurate and reliable. But their accuracy, reliability, or completeness is not guaranteed.

Schonstedt's only obligation shall be to repair or replace any instrument proved to be defective within seven years of purchase. Schonstedt shall not be responsible for any injury to persons or property, direct or consequential, arising from the use of any instrument.

Operation

Introduction

The GA-52Cx Magnetic Locator detects the magnetic field of a ferromagnetic object. It responds to the difference in the magnetic field between two sensors spaced about 20 inches apart. The response is a change in the frequency of the signal emitted by the piezoelectric speaker.

Figure 1 illustrates an application of the locator in which it is used to detect an iron marker of the type used for property line identification. As shown, the magnetic field of the iron marker is stronger at sensor **A** than it is at sensor **B**. As a result, the frequency from the piezo electric speaker is higher than the idling frequency, 40 Hz, which exists when the field strength is the same at both sensors.

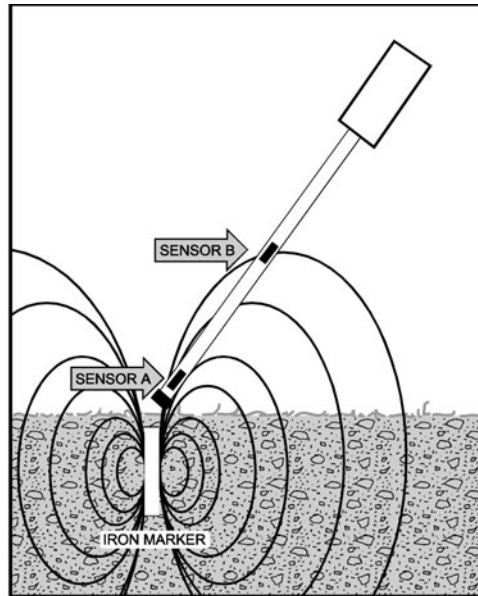

Figure 1. Detecting Magnetic Field of an Iron Marker

Turn-On, Sensitivity and Volume Settings

Set the On-Off/Sensitivity Control to position 2 and adjust the Volume control until the idling tone reaches a desired level. Setting the Sensitivity control to position 2 provides what is referred to as the “Normal Operating Range.” Positions 3 to 5 increase the sensitivity; position 1 decreases the sensitivity.

The locator can be oriented in any direction without producing a significant change in the frequency of the tone from its idling frequency.

When using headphones the Volume Control has no affect on the output level of the audio signal.

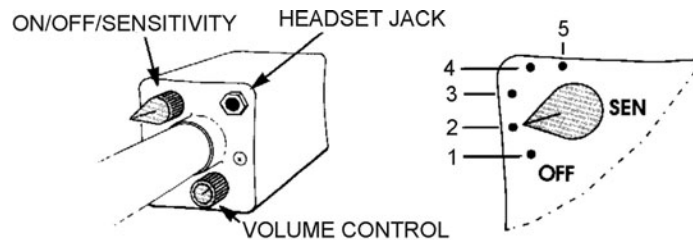

Figure 2. Sensitivity Set for Normal Range (position 2)

Search Procedure

Set the sensitivity control to position 2 (Normal Range) and grasp the locator as illustrated. Because the upper sensor is located near where the locator is usually held, wrist watches may produce unwanted changes in the tones frequency. (Remove your wrist watch or hold the locator in the other hand). Keep the locator away from your shoes, since they might contain magnetic material.



To obtain maximum area coverage, the locator should be swept from side-to-side. When the locator comes within range of an object, you will hear an increase in the frequency of the output signal.

Figure 3. Searching with the locator

Application Notes

Basic Signal Patterns

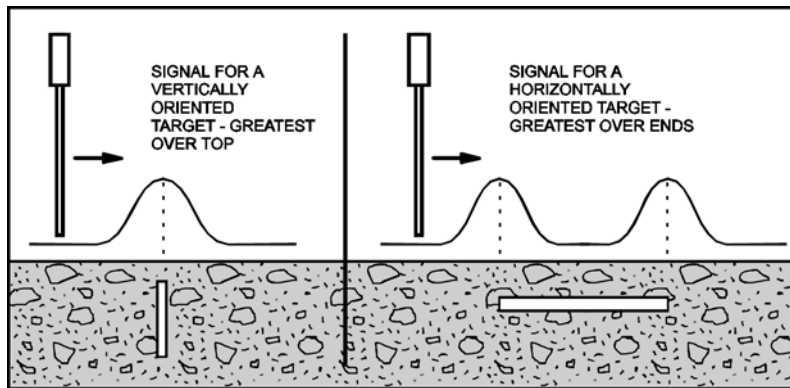

Figure 4. Signals from Vertical and Horizontal Targets

After you have detected the presence of a target, hold the locator vertically and move it back and forth in an “X” pattern. The peak signal occurs directly over a vertical target, and over the ends of a horizontal target.

The “X” pattern is ideal for pinpointing small objects. A 1-1/4-inch PK nail buried up to 12 inches can be located so precisely with this technique that it can be uncovered using a 1/2-inch star drill.

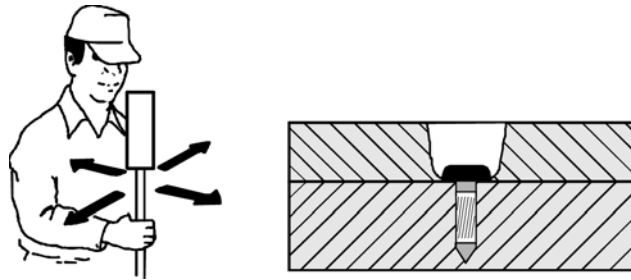

Figure 5. “X” Pattern Provides Precision Locating

If you find more than one signal in the vicinity of a target, just raise the locator several inches higher or reduce the sensitivity setting. Any signal that disappears when the locator is raised or the sensitivity is reduced is probably not coming from the actual target. The signal from a rusty bolt or other small item will decrease much faster with distance than the signal from a larger target such as a corner marker. An 18-inch length of 3/4-inch pipe can be located at depths up to 9 feet.

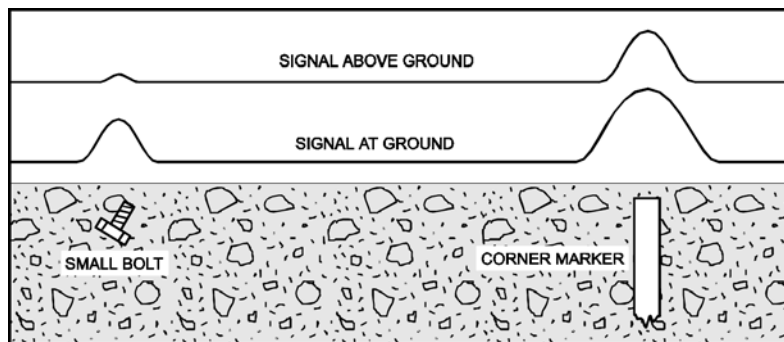

Figure 6. Raising the Locator Eliminates Unwanted Signals

Strongly Magnetized Markers

A strongly magnetized marker at or near the surface may provide location information that is misleading.

The heavy line in Figure 7 represents the variations in tone frequencies when the locator is moved over the marker. When moving the instrument from **A** to **B**, the frequency of the tone increases and then suddenly decreases at **B**. From just beyond **B** the frequency of the tone increases sharply, becomes very high directly over the marker and decrease just before reaching **C**. From **C** to **D** the pattern is the reverse of that from **A** to **B**. It is obvious that the locator must enter the **B-C** region. Otherwise the marker might be assumed to be between **A** and **B**, or **C** and **D**.

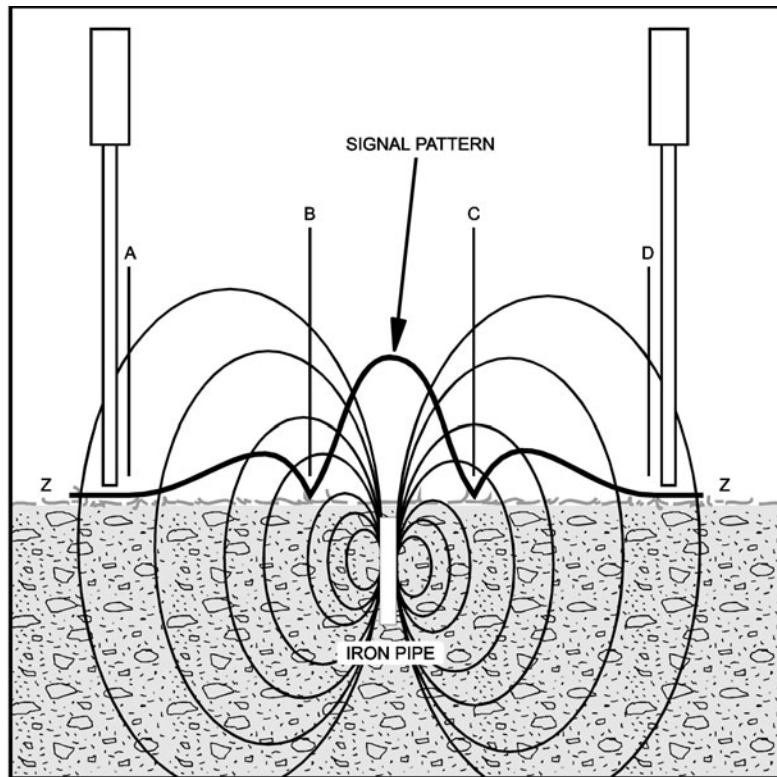

Figure 7. Signal Pattern From a Strongly Magnetized Marker

This phenomenon is explained by the fact that the locator is sensitive to the magnetic field components parallel to its long axis. At points **B** and **C** the field is perpendicular to the locator so no high frequency is produced at these points.

Locating Manholes, Septic Tanks and Well Casings

The magnetic field is strongest at the edge of a shallow manhole cover. You can easily trace the edges of covers near the surface. Locating depth ranges up to 10 feet.

The great length of a well casing provides a strong field at the surface that makes it easy to locate casings buried up to 18 feet deep.

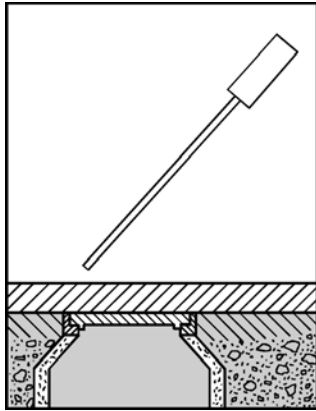

Figure 8. Locating Manhole Covers

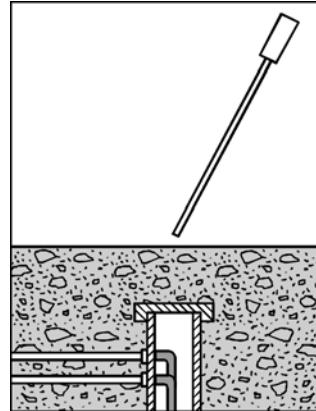

Figure 9. Locating Water Well Casings

The GA-52Cx can be used to precisely locate the metal handles or reinforcing bars on septic tank covers at depths of up to 4 feet.

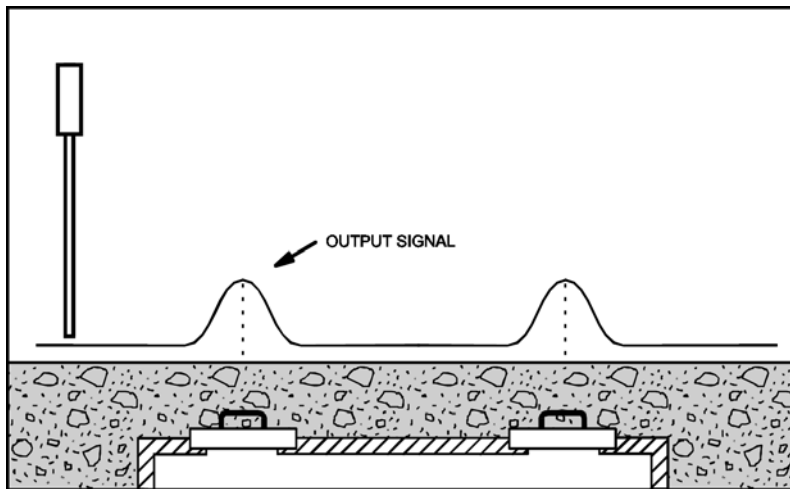

Figure 10. Signal Pattern Provided by Septic Tank Covers

Locating Objects under Snow or Water and Tracing Barbed Wire

The locator can be used in flooded areas, just keep the electronic unit out of the water.

Snow poses no problem. Thrust the locator into the snow as deep as necessary to locate the target.

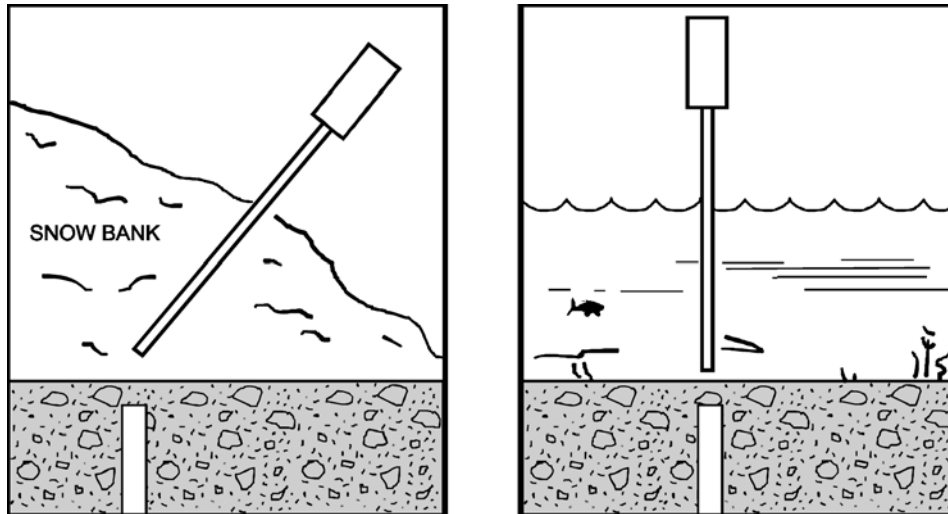

Figure 11. Locating Objects Under Snow or Water

You can often trace barbed wire (from old fence lines) buried just beneath the surface. Even if the wire is only a trail of rust it can still be detected near the surface. Tip the locator a little lower than usual, but not parallel with the ground.

First, examine trees for bench marks and bits of embedded barbed wire. Then hold the locator parallel with the direction of the wire.

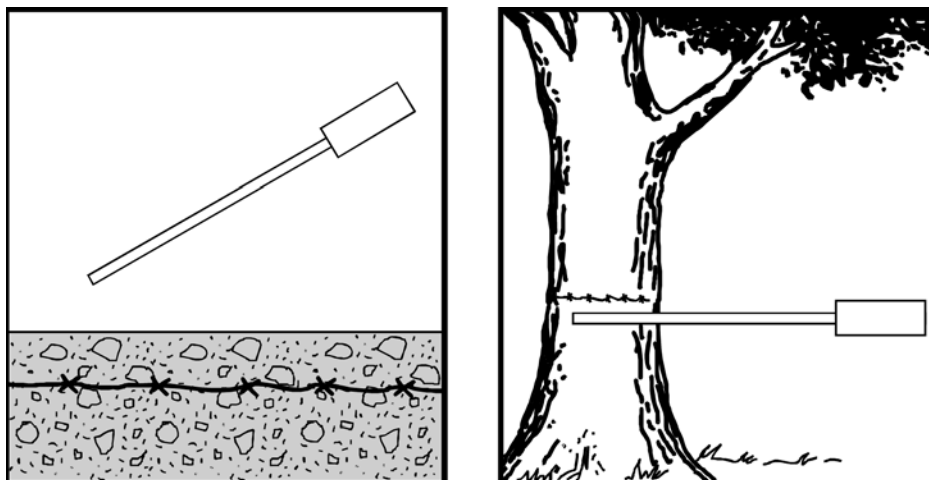

Figure 12. Tracing Barbed Wire from Old Fence Lines

Searching Areas Along a Chain Link Fence

Searching in the vicinity of a chain link fence requires a reduced sensitivity setting and also some control over the orientation of the locator. As illustrated in Figure 13, position the locator horizontally, with its long axis perpendicular to the fence. This ensures that the upper sensor is kept away from the fence.

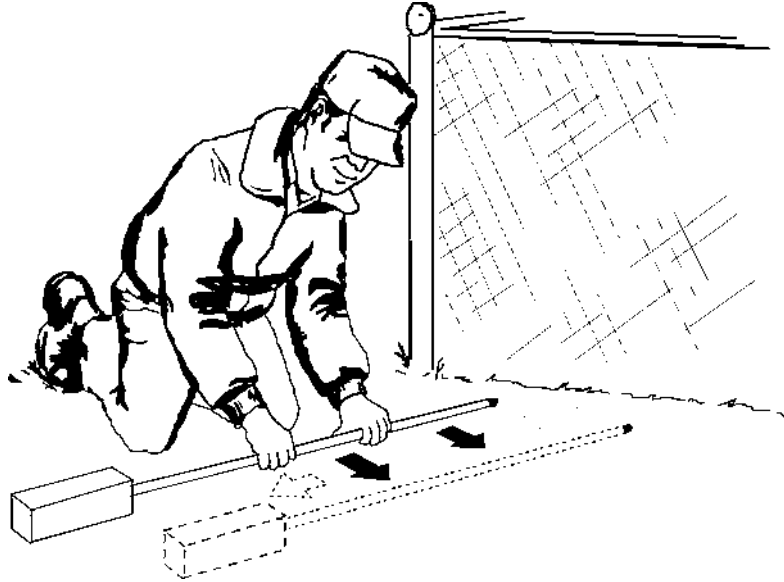

Figure 13. Searching in the Vicinity of a Chain Link Fence

Perform the search by slowly moving the locator forward along the fence while also moving it in to the right and to the left. This technique allows you to search an area several feet wide as you move forward. **Listen for an abrupt drop in the signal, (as shown by the null in Figure 14.) that will occur when the lower sensor, located 1-5/8 inches from the end of the locator, is directly over the stake.** Any variation in the position of the locator will produce an abrupt rise in the frequency of the signal.

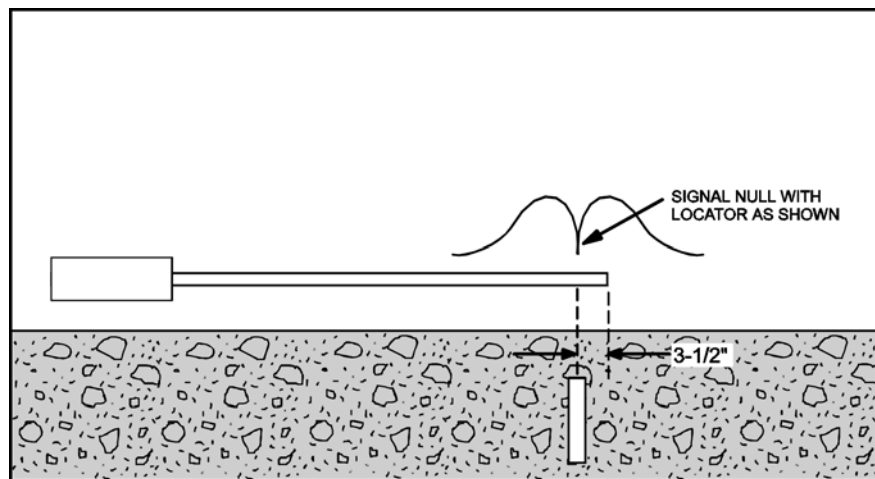

Figure 14. Placement of Locator While Searching Along a Chain Link Fence

Locating Valve Boxes

Both the valve and its casing, when iron, provide strong magnetic fields that make them easy to locate. Plastic enclosures containing magnets are easily located at depths of 10 feet or more.

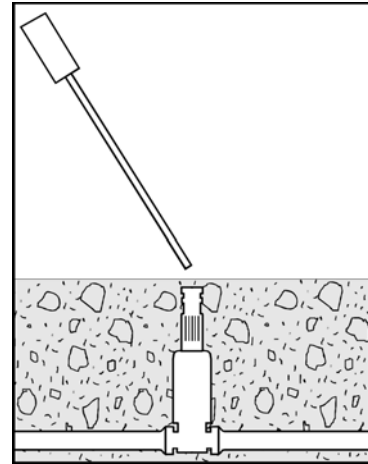

Figure 15. Locating Valve Boxes and Casings

Locating Cast-Iron Pipes

As illustrated in Figure 16, cast-iron pipes produce the strongest magnetic signals at their joints.

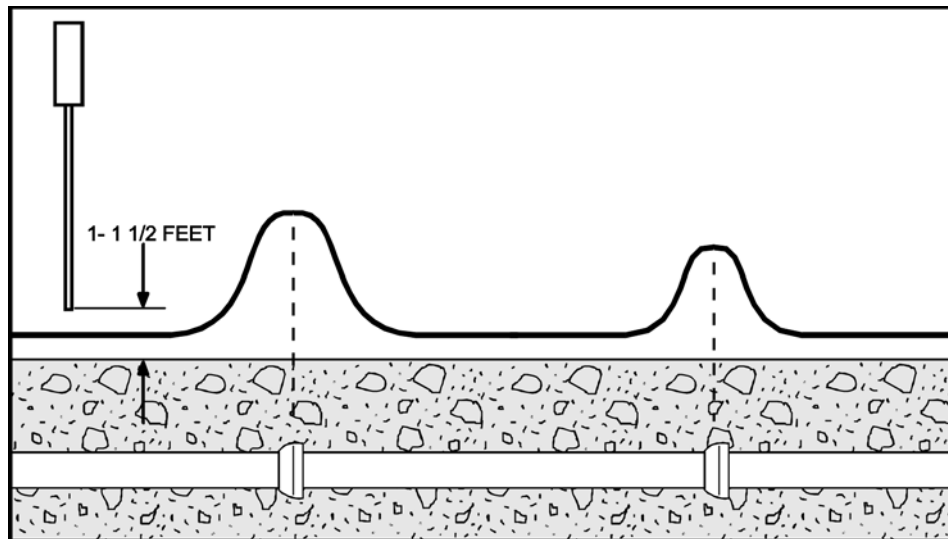

Figure 16. Signal Patterns Provided by Cast-Iron Pipes

The initial search should be performed as follows:

1. Adjust the sensitivity level for maximum.
2. Hold the locator vertically approximately 1 to 1-1/2 feet above the surface.
3. Walk along without turning or tilting the locator.
4. Mark the locations where the maximum signal levels occur.
5. Return to an area of maximum signal strength and hold the locator several inches above the surface. The sensitivity will probably have to be reduced during this second pass. Four-inch pipes can be located at depths of up to 10 feet.

Locating Steel Drums

As shown in Figure 17, the GA-52Cx's signal pattern will vary depending on the vertical or horizontal orientation of the drum and also how deep it is buried. A fifty-five gallon drum can be located at depths of up to 10 feet.

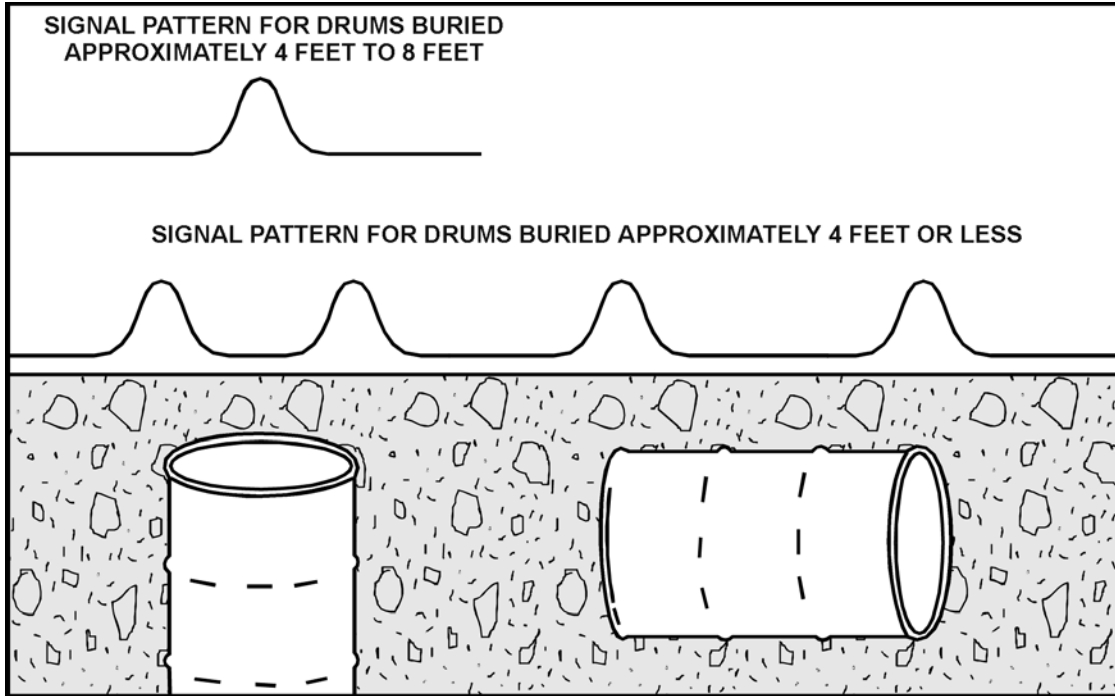

Figure 17. Signal Patterns Provided by Steel Drums

Additional Applications

1. The military and many local and state police departments use the GA-52Cx to detect buried ordnance and discarded weapons.
2. People drilling in an area where hazardous materials might be encountered use the GA-52Cx to search the area prior to drilling. Other Schonstedt magnetometers are available that can be lowered down the hole for periodic checks as drilling progresses.

Other Notes

1. A burbling sound indicates the presence of an energized power line.
2. The instrument will not detect non-magnetic materials such as gold, silver, copper, brass and aluminum.

Maintenance

The GA-52Cx is designed and built to give trouble-free operation. Normally, maintenance is limited to the occasional replacement of batteries. In the event that a malfunction does occur, refer to the troubleshooting guide on page 11. It lists a few problems that can generally be corrected in the field so that you will be able to continue using the locator without interruption.

Replacement of Batteries

The GA-52Cx is powered by two alkaline 9-Volt batteries. Alkaline or lithium batteries may be used, however lithium batteries are recommended for their exceptional performance. The battery manufacturers advertise a 10 year shelf life, two to four times the operational life of an alkaline battery, as well as being environmentally safe. If battery leakage does occur, lithium batteries do not cause severe damage to the unit as would alkaline batteries.

The batteries are carried in the battery holder as illustrated in Figure 18. Access to the batteries is obtained by removing the two knurled nuts and sliding off the cover. *Always replace both batteries.*

NOTE: When replacing the batteries hold the instrument by the metal chassis to avoid any contact with the printed circuit board and its components.

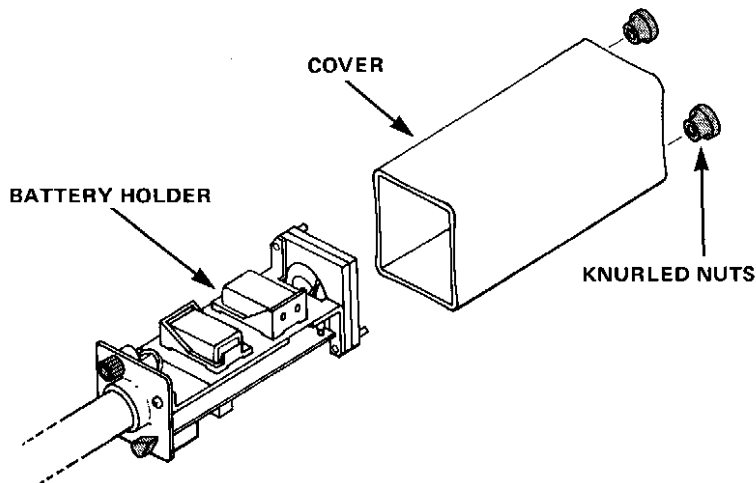

Figure 18. Exploded View of the Electronics Unit Cover

Troubleshooting Guide

Symptoms	Possible Cause	How to Check	How to Fix
Dead	Dead Batteries	Replace	-----
	Batteries not making contact	Check for contact corrosion	Clean contacts
	Battery leakage	Do not remove*	Return unit to factory
Intermittent	Batteries not making good contact	Check for corrosion	Clean contacts
Uncontrollable screaming	Weak batteries	Replace	-----

** Most battery manufacturers' warranties cover the cost of repair or replacement of any device damaged by their batteries. Removing batteries that leak will void their warranty.*

SERVICE INFORMATION

If your locator needs service, please return it to the factory (in its case) along with the following information: Name, Address, Telephone and Fax Numbers, Where Purchased, Date of Purchase, and Description of Problem(s). A tele-faxed estimate will be provided prior to service work being done. See shipping information.

SPECIFICATIONS

(Specifications subject to change without notice.)

Input Power	Supplied by two alkaline 9-V batteries
Battery Life	40 hours (Intermittent usage)
Output	Approximately 40 Hz idle tone in speaker. Tone frequency increases (or decreases) with gradient-field intensity.
Weight	Approximately 2.5 lb. (1.13 kg)
Operating Temperature	-13 F to 140 F (-25 C to 60 C)
Overall Length	42-5/16 in (107.4cm)
Waterproof Length	34-1/2 in. (87.6 cm)
Nominal Sensor Spacing	20 in. (50.8 cm)
Construction	Rugged, modular all solid state

LIMITED WARRANTY

The Schonstedt Instrument Company (Schonstedt) warrants each product of its manufacture to be free from defects in material and workmanship subject to the following terms and conditions. The warranty is effective for 7 years (with the return of the Customer Registration Card) after the shipment by Schonstedt to the original purchaser.

Schonstedt's obligation under the warranty is limited to servicing or adjusting any product returned to the factory for this purpose and to replacing any defective part thereof. Such product must be returned by the original purchaser, transportation charges prepaid, with proof in writing, to our satisfaction, of the defect. If the fault has been caused by misuse or abnormal conditions of operation, repairs will be billed at cost. Prior to repair, in this instance, a cost estimate will be submitted. Service or shipping information will be furnished upon notification of the difficulty encountered. Model and serial numbers must be supplied by user. Batteries are specifically excluded under the warranty.

Schonstedt shall not be liable for any injury to persons or property or for any other special or consequential damages sustained or expenses incurred by reason of the use of any Schonstedt product.

**FOR SERVICE OR REPAIR
Please ship locator (in its case) to:**

**Schonstedt Instrument Company
100 Edmond Road
Kearneysville, WV 25430**

PATENTS

Manufactured under one or more of the following Patents: United States: 4,163,877; 4,258,320; 4,803,773; 4,839,624; 5,097,211; 5,136,245; 5,138,761; 5,239,290. Other United States and foreign patents pending.